



# User and Installation Manual



## **Information ownership**

© COPYRIGHT 2017, Teledata s.r.l.

All rights reserved.

Any full or partial distribution, modification or reproduction of this document are prohibited without written authorization by Teledata s.r.l. except the following actions:

- Fully or partially printing the document in its original format.
- Transferring the document on web sites or other electronic systems.
- Copying content without editing it and quoting Teledata s.r.l. as the owner of the copyright.

*NOTE: the content of this document cannot thus, be used to develop other content for your retail purposes without a written authorization by Teledata s.r.l.*

*Requests for additional copies of this product or pertinent technical information should be addressed to:*

**Teledata s.r.l.**

**20132 Milan - Italy - Via G.M. Giulietti, 8**

**Tel.: +39 02 27 201 352 / +39 02 25 92 795**

**Fax: +39 02 25 93 704**

**E-mail: [info@teledata-i.com](mailto:info@teledata-i.com)**

## **Declaration of conformity**

This equipment was designed according to the quality, reliability and performance criteria adopted by Teledata.

Equipment must be professionally installed according to current regulations.

The equipment meets the following directives and standards:

EMC Directive (EMC) **2004/108/EC**

Low Voltage Directive (LVD) **2006/95/EC**

EN 54-2

EN 54-4 (A2:2006)

# INDEX

<b>1.</b>	<b>Introduction to this manual</b>	<b>7</b>
1.1	Obligations to this manual	7
1.2	Manual data	7
1.3	Warnings for manual addressees	7
<b>2.</b>	<b>Safeties and warranties</b>	<b>8</b>
2.1	Safety rules	8
2.2	Intended use	8
2.3	Warranty restrictions	8
2.4	Technical support	8
<b>3.</b>	<b>Product identification</b>	<b>9</b>
3.1	Manufacturer's identification data	9
3.2	Packaging content	9
3.3	Identify the model and the serial number	9
3.4	Standards compliance	10
<b>4.</b>	<b>Equipment management</b>	<b>11</b>
4.1	Transportation	11
4.2	Environmental conditions	11
4.3	Unpacking	11
4.4	Replacement	11
4.5	Disposal	11
<b>5.</b>	<b>Introduction to ONEMINI</b>	<b>12</b>
5.1	General features	12
5.2	Installation precautions	12
5.3	Technical specifications	13
5.3.1	HARDWARE features	13
5.3.2	Software features	13
5.4	Technical data	14
5.4.1	Datum plate	14
5.4.2	Electrical features	14
5.4.3	Functional features	14
5.4.4	Mechanical features	14
5.4.5	Environmental features	14

<b>6.</b>	<b>Hardware Configuration</b>	<b>15</b>
6.1	Control Panel Equipment	15
<b>7.</b>	<b>Layout and connections</b>	<b>16</b>
7.1	Logic board (TD595) layout	16
7.2	ONECONNECT Card (optional)	18
7.3	ONERING Card (optional)	20
7.4	Power supplies and batteries	23
7.5	System description	24
7.5.1	Relations between the elements of the plant	24
7.5.2	Sounder and load connection	24
7.6	Communication with detectors and modules	25
7.6.1	Open loop configuration	25
7.6.2	Generic loop connection requirements	26
7.6.3	Open loop configuration ("T" junctions)	26
7.6.4	Open loop connection with "T" junctions connection requirements	26
7.6.5	Closed loop configuration	27
7.6.6	Connection requirements for a closed loop connection	27
7.6.7	Connectable loop devices	27
7.7	Connection to host computer	32
7.7.1	Point to Point connection	32
7.7.2	LAN or WAN connection	33
7.7.3	ONEMINI control panel ring network	34
7.8	Power supply	35
7.8.1	Network input features	35
7.8.2	Grounding features	35
7.8.3	Panel power supply features	35
7.9	Panel internal cabling	36
<b>8.</b>	<b>Control panel</b>	<b>38</b>
8.1	Status led	38
8.2	Graphic interface	39
8.3	Types of users	39
8.4	Access levels	40
<b>9.</b>	<b>Basic operations for any operator</b>	<b>41</b>
9.1	View basic information	41
9.1.1	Viewing events	42
9.1.2	Viewing assistance information	43

9.2	Login	44
-----	-------	----

---

<b>10.</b>	<b>Configuration</b>	<b>46</b>
------------	----------------------	-----------

---

10.1	Setting up the panel	46
10.1.2	Run auto-addressing	47
10.1.3	Run self-programming	47
10.2	All In All Out configuration	48
10.3	Detectors configuration	49
10.4	Modules configuration	52
10.5	Zones configuration	55
10.5.2	Link an event to a zoneSettings	55
10.5.3	Linking loops to zones	55
10.5.4	Linking devices to zones	56
10.5.5	Set zone operating parameters	57
10.5.6	Link an output module to a zone	58
10.6	Output zones configuration	60
10.7	Logic functions configuration	61
10.8	Setting system parameters	65
10.7.1	Setting the language	65
10.7.2	Entering panel information	65
10.7.3	Setting led and buzzer behavior	66
10.7.4	Setting remote communications	67
10.7.5	Setting loop features	67
10.7.6	Restoring factory settings	68
10.7.7	Setting peripheral features	68
10.7.8	Exporting data	68
10.7.9	Import data	69
10.7.10	Various system settings	70
10.8	Setting the calendar.	71
10.8.1	Setting the date and time	71
10.8.2	Setting daylight savings time	71
10.8.3	Setting holidays	73
10.8.4	Setting time intervals	73
10.8.5	Setting weekly trends	74

---

<b>11.</b>	<b>Use</b>	<b>75</b>
------------	------------	-----------

---

11.1	Viewing events	75
11.1.1	Exporting data	75
11.2	Enabling users and changing login codes	76
11.2.1	Programmer	76
11.3	Managing alarms	76

11.3.1	Mute alarms and the unit	77
11.3.2	Reset alarms and the unit	77
11.3.3	Evacuation	77
11.4	Checking device status	78
11.4.1	Check loop status	78
11.4.2	Resetting a loop	78
11.4.3	Run device diagnostics	78
11.4.4	Diagnostics export.	79
11.5	Testing devices	79
11.5.1	Running a Walk Test	79
11.5.2	Testing the connection with modules and sensors	80
11.5.3	Identifying conflicts	80
11.5.4	Identifying mismatches	81
11.5.5	Testing led operations	81
11.6	Disable system elements	82
11.6.1	Disabling/Enabling a device	82
11.6.2	Disabling/Enabling a loop	83
11.6.3	Disabling/Enabling a zone	83
11.6.4	Disabling/Enabling an output	84
11.6.5	Disabling/Enabling a board	84
11.7	Modify a user password	84
11.7.1	Reminder	85

---

---

# 1.Introduction to this manual

## 1.1 Obligations to this manual



Warning: this manual is an integral part of the equipment and must be kept for its entire working life. The manual must be enclosed with the equipment in the event of transfer to third parties.

The manual must be consulted for all those situations tied to the equipment's working life from its receipt until its disposal.

It must be kept in a clean place accessible to operators, and kept in good conditions.

## 1.2 Manual data

<b>Equipment:</b>	ONEMINI
<b>Title:</b>	User and Installation Manual
<b>Code or edition:</b>	v. 1.0.6 ENG
<b>Print month and year:</b>	November 2020
<b>Manual type:</b>	original instructions

## 1.3 Warnings for manual addressees

Graphic concepts adopted in the text are illustrated below.



Warning: operations to be carefully performed or important information.



Note: important information, highlighted after the text they refer to.



Suggestions: practical information for good function operations.

## 2. Safeties and warranties

### 2.1 Safety rules

The information in this manual section aim to ensure that the device is correctly installed and handled. It is assumed that anyone who has to do with the device is familiar with the content of this chapter.

### 2.2 Intended use

The equipment must only be installed and used as described in this manual and for the purposes described in the advertising material distributed by Teledata S.r.l. It can only be connected to equipment, components and devices manufactured by third parties as recommended and permitted in this manual or by Teledata S.r.l. directly.

The equipment was designed, manufactured and tested to meet the stated safety standards. If, during the design of the systems in which it is installed, installation and use the instructions in this manual are followed, the equipment is not harmful to people or property.

### 2.3 Warranty restrictions

Teledata is not liable for direct or indirect damages to people or property due to equipment use in conditions other than those intended.

Qualified personnel must install this equipment strictly following the instructions in this manual and according to local laws, standards and safety regulations in effect.

This product is guaranteed against material and factory defects for **12 months from inspection date**. The warranty does not cover defects due to:

- Improper use and neglect.
- Damages due to exposure to the elements.
- Vandalism.
- Material wear.

The warranty is invalid when faults are due to improper use or operating procedures not contemplated in this user manual.

### 2.4 Technical support

This manual was drafted with care and is intended for qualified personnel. For any questions or special technical requests, please contact our personnel. Please write or call to contact personnel able to answer your questions and provide assistance.

Service email: [info@teledata-i.com](mailto:info@teledata-i.com)

Service phone number: +39 0227201352

Service fax number: +39 022593704



### 3. Product identification

#### 3.1 Manufacturer's identification data

Teledata s.r.l.

Head office 20132 Milan - Italy - Via G.M. Giulietti, 8

Operating center 20063 Cernusco Sul Naviglio - Italy - Via Brescia, 24

Tel.: +39 02 27 201 352 / +39 02 25 92 795

Fax: +39 02 25 93 704

E-mail: [info@teledata-i.com](mailto:info@teledata-i.com)

#### 3.2 Packaging content

The packaging contains the following items:

Description	Quantity
ONEMINI panel	1
Resistances, diodes and jumpers kit	1
Installation and user manual (this manual)	1

#### 3.3 Identify the model and the serial number

Inside and out the box of the panel there are identification stickers that must not be removed under any circumstance. Please see plate information for service calls, maintenance or accessories.



### 3.4 Standards compliance

- **EN 54-2:** Fire detection and fire alarm systems - Control and indicating equipment.
- **EN 54-4:** Fire detection and fire alarm systems - Power supply equipment (integrated in the control panel).
- **Product type:** Fire detection and fire alarm systems for buildings.
- **Intended use:** Fire safety.

Essential characteristic	Harmonized tech. spec.	
	EN54/2:1997/A1:2006/AC1999	EN54/4:1997/A2:2006/AC:1999
Performance under fire condition	cl. 4, 5, 7	-
Response delay (response time to fire)	cl. 7.1, 7.7	-
Operational reliability	cl. 4, 5, 6, 7, 8, 9, 10, 12, 13, 14	cl. 4, 5, 6, 7, 8
Durability of reliability: Temperature resistance	cl. 15.4	cl. 9.5
Durability of reliability: Vibration resistance	cl. 15.6, 15.7, 15.15	cl. 9.7, 9.8, 9.15
Durability of reliability: Electrical stability	cl. 15.8, 15.13	cl. 9.9
Durability of reliability: Humidity resistance	cl. 15.5, 15.14	cl. 9.6, 9.14

## **4. Equipment management**

### **4.1 Transportation**

Once the equipment is carefully packaged and boxed, typical precautions must be taken during transport meaning the box must be positioned and secured to avoid tipping or falling that could damage equipment. Temperature limits must also be observed.

### **4.2 Environmental conditions**

Observe temperature limits:

-40° / +70°C for storage and transport.

-5° / +40°C for operations.

### **4.3 Unpacking**

Upon receiving the equipment, carefully unpack, being careful to dispose waste according to current waste disposal regulations.

### **4.4 Replacement**

To replace obsolete equipment, disconnect it and connect the new device according to the relevant installation diagrams.

Dispose of the old equipment according to current waste disposal regulations.

### **4.5 Disposal**

Avoid destruction by incineration and disposal in waterways. The product must be safely disposed.

Before disposal, batteries must be removed from all products containing batteries being careful to avoid short circuits. Observe current regulations for battery disposal.

## 5.Introduction to ONEMINI

### 5.1 General features

ONEMINI is a microprocessor-programmable fire detection control panel. This control panel uses an analogue addressed system and an autonomous management of indications and warning procedures.

The control panel is able to manage the fire detection through 1 analogue addressed lines.

The loop can control up to 240 detectors and IN/OUT modules.(120 devices for S Light version)

The system is provided with a 32-bit microprocessor with RAM, flash memory and EEPROM memory for the non-volatile storage of the configuration data.

The control panel can be programmed using the touch screen or by importing programming data from a USB key.

Like all Teledata products, ONEMINI can be managed through the integrated supervisory and control software.

### 5.2 Installation precautions

The electronic boards are provided with semiconductors that are sensitive to electrostatic charges. For this reason the boards should be handled by their edges and their electronic components should not be touched.

Carry out a good grounding in order to reduce the damageability and noise sensibility.

During the phase of designing the system, required autonomy should be taken into consideration in order to scale the batteries to be utilized.

Disconnect the batteries, the AC power and any power supply before inserting or removing an electronic board and before carrying out any maintenance work on the control panel (except for the loading of a new FW version).

Peripheral devices like detectors, modules, sounders etc. that are not compatible with the control panel can cause an improper operation of the control panel or even damage it.

It is therefore necessary to use materials compatible with the Teledata control panels.

ONEMINI control panel must be used with n°2 12V - 7.2Ah batteries

## 5.3 Technical specifications

### 5.3.1 HARDWARE features

- 32 bit microprocessor addressable control panel.
- 1 loop addressable with digital protocol, configurable as open or closed.
- Graphic touch screen display (480x272 TFT 4.3”).
- Loop short circuit protection.
- 14 front LEDs.
- 2 supervised output for siren or dialer (20,6 to 27,6Vdc @ 500mA).
- 1 alarm form C output (30Vdc @ 1A).
- 1 fault form C output (30Vdc @ 1A).
- 1 RS-485 line for peripherals.
- 1 RS-232 for supervisor data communication.
- 1 USB for data import export
- Colored side led.
- 16 zone leds. (OPTIONAL board TD596A).
- Battery capacity: 2x7.2Ah with EN54-4 charger management.
- Supervised AUX power supply output 20,6 to 27,6Vdc @ 1A with shortcut protection.
- Dimensions: 330x310x80 mm
- Power Supply: 230V AC

### 5.3.2 Software features

- Up to 240 addressable device ( 120 for S-Light version)
- Up to 240 addressable device (Oneprotocol)
- Up to 240 addressable device (Argus)
- Up to 126 addressable device (Apollo XP95/ Discovery)
- Up to 240 addressable device (Apollo Soteria)
- Splitting up to 192 detection zone.
- 192 logical functions.
- Archival more than 850 events.
- Analog loops auto programming.
- Analog loops auto addressing (ARGUS only).
- Connection with other control panels using a fault tolerant network.
- Multiple language management.
- Fully customizable with personal logo, color and multicolored side LEDs.
- Management of different types of analog detectors and modules:
  - Thermal, optical and mixed detectors
  - Input Modules
  - Output Modules
  - Addressed call points
  - Addressable sirens
  - Wireless translator

## 5.4 Technical data

### 5.4.1 Datum plate

Primary voltage	230 Vac / 50 Hz
Primary consumption	200mA ~
230V~ fuse	F4Ah

### 5.4.2 Electrical features

Minimum operating voltage	21.6 V
Backup batteries	n° 2 (12Vdc/7.2Ah)
Maximum internal batt resistance	800mOhm
Available current for external loads	1A
Standby absorption	300 mA – 27,6V
Monitored sounder line	Max. 500mA – 20,6 to 27,6DC
Fault relay	Max. 1A - 30V DC/120V AC

### 5.4.3 Functional features

Operating keyboard	Touch screen
Optical messages	Led
Acoustic messages	Buzzer
Visualization of the events	480x272 TFT 4.3"
Serial output for PC	N° 1 – RS232
Event log	Max. 850
Working mode	Guarded/Unguarded
Programming/Management hardware key	Multilevel password
Number of analogue lines	1 loop
Exclusion of the analogue line	Single – multiple
I/O Modules / Detectors	Max. 240 ( max 120 for S-Light)
Programming type	Manual or by PC
Configuration of the analogue line	192 software zones
Analogue lines connection	Open or closed loop
Length of the detector lines	Max. 5000m
Type of cable	Shielded

### 5.4.4 Mechanical features

Protection level	IP30
Cabinet	Iron
Dimensions (WxLxD)	330 x 310 x 80 mm
Weight (without batteries)	6 Kg
Painting	Epoxy resin
Color	Black
Conduit holes	4 x 25 mm

### 5.4.5 Environmental features

Storage temperature	(-40 ÷ +70)°C
Operating temperature	(-5 ÷ +40)°C
Operating humidity (relative)	90%

## 6. Hardware Configuration

### 6.1 Control Panel Equipment

When fully equipped the control panel can include:

- 1 main logic board (TD595)
- 1 synoptic led (ONE16 TD596)
- 1 ONECONNECT network card (for LAN or WAN network connection)
- 1 ONERING card (for panel network connection)
- 2 batteries (max 12V @ 7,2 Ah)

# 7. Layout and connections

## 7.1 Logic board (TD595) layout

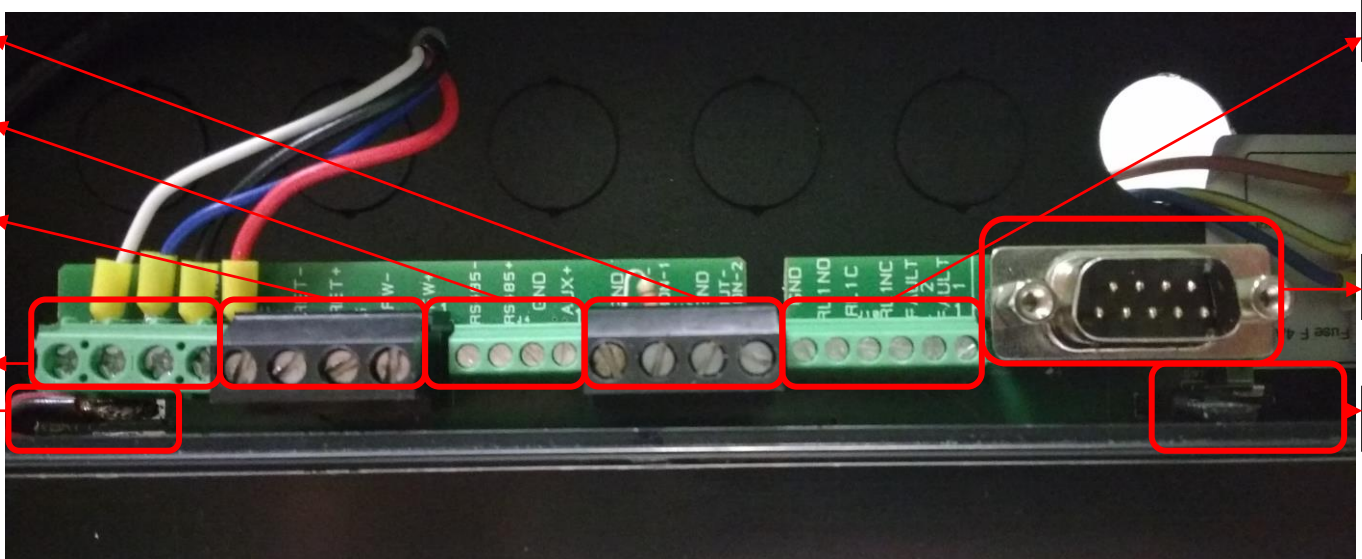
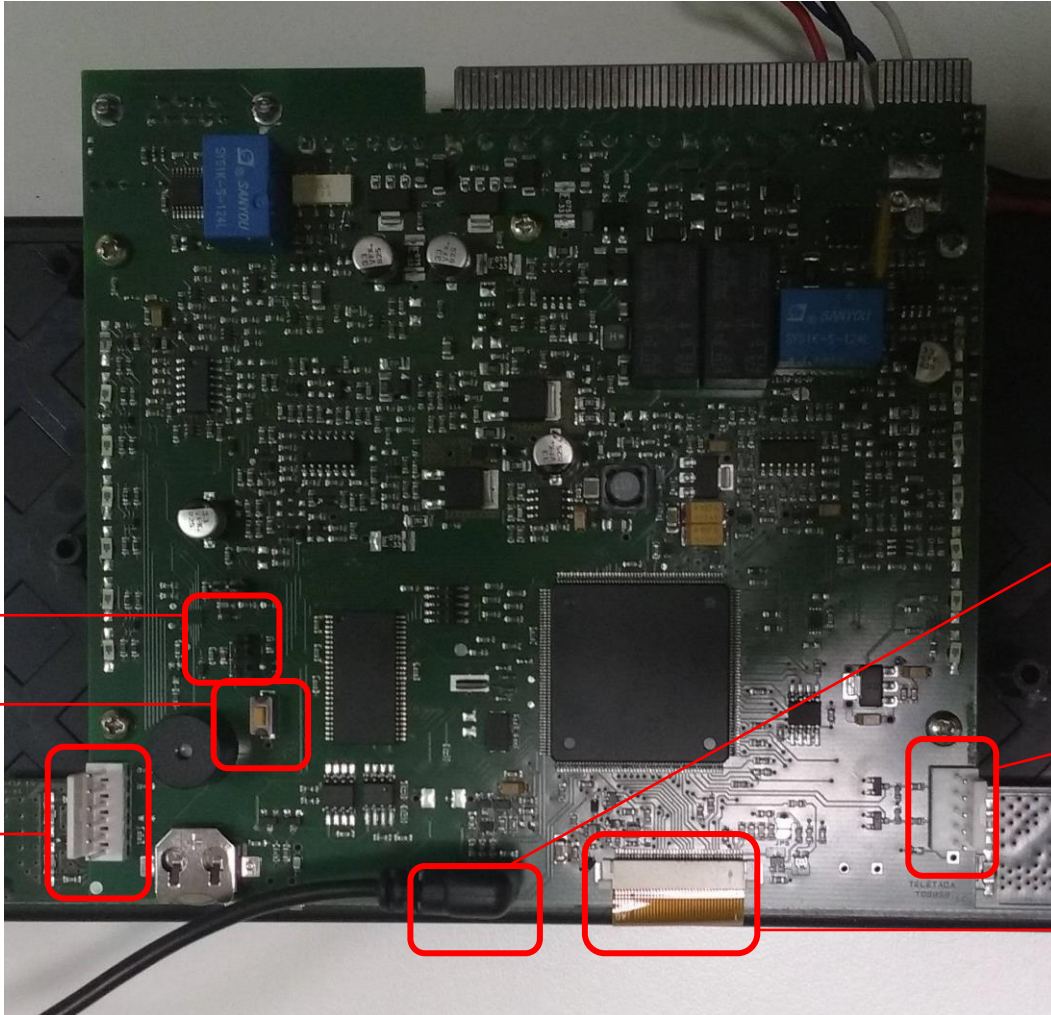



The following connectors are available:

- **Connector J7:** ONERING card connections
- **Connector Y2:** touch screen connection
- **Connector J11:** ONECONNECT card connections
- **Connector J13:** Batteries connection
- **Connector J1:** AL1 power supply and DIM power supply control
- **Connector J9:** fire loop send and return
- **Connector J4:** RS-485, AUX, fault output
- **Connector J10:** form C alarm and form C fault
- **Connector J6:** for RS-232 connection.
- **Connector JP3:** for programming protection (closed=enabled)
- **Connector JP4:** to set watchdog state.
- **Connector J12:** supervised output for siren or dialer
- **Connector Y3:** connector USB port
- **Connector Y4:** Factory reset button



Y3 and J1 are connectors with predefined wiring and should be connected to elements that are already installed in the control panel. These connectors should be disconnected and reconnected only in case boards have to be replaced or added.

The respective wiring of the connectors J9, J4, J10, J6, J11 and J7 depends on the equipment configuration in which the control panel is connected.

Further on are described the connector functionalities.

#### Connector J13

PIN no.	NAME	FUNCTIONALITY
1	VBATT-	Batteries negative power supply
2	VBATT+	Batteries positive power supply

**Warning: if a short circuit on battery is done when power supply is switched on, a quick reset shall happen on control panel and a "system fault" event should appears.**

#### Connector J1

PIN no.	NAME	FUNCTIONALITY
1	DIM-	DIM- control PS1 power supply
2	DIM+	DIM+ control PS1 power supply
3	GND	Negative alim
4	PS+	Positive alim

#### Connector J9

PIN no.	NAME	FUNCTIONALITY
1	RET-	Loop Return -
2	RET+	Loop Return+-
3	FW-	Loop Send-
4	FW+	Loop Send+

#### Connector J4 and J12

PIN no.	NAME	FUNCTIONALITY
1	485-	RS-485 line -
2	485+	RS-485 line +
3	GND	Ground
4	AUX+	AUX power output (27Vdc @ 500mA)
5	GND	Ground

PIN no.	NAME	FUNCTIONALITY
6	OUTMON1	Output monitored 1
7	GND	Ground
8	OUTMON2	Output monitored 2

**Connector J10**

PIN no.	NAME	FUNCTIONALITY
1	GND	
2	RL1NO	
3	RL1C	
4	RL1NC	
	FAULT2	
	FAULT1	

## 7.2 ONECONNECT Card (optional)

The ONECONNECT card, if included, is supplied with a flat cable and must be connected to the main board on connection J3 as shown below:

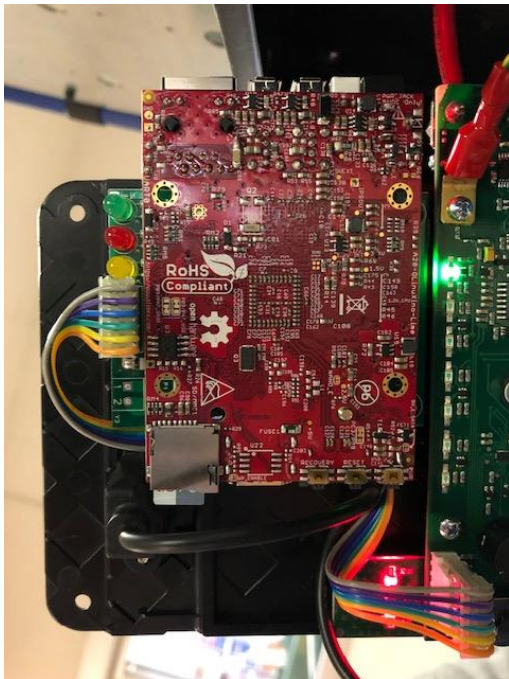

Connect as shown:

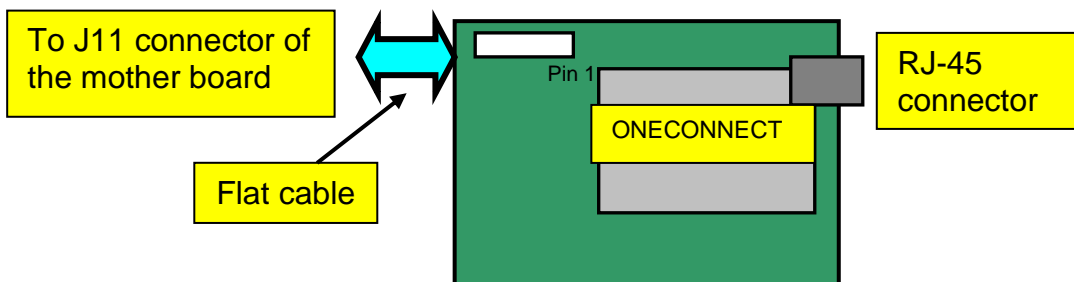

- Connect the flat cable to the connector J3 of the network card and to connector J11 of the main board.



To avoid damaging, do not force connector insertion.

Connect the control panel to the network card on connector RJ-45 of the network card using:

- **10BASE-T crossed** network cable: for connection to the host PC
- **10BASE-T direct** network cable: for connection to a hub.

### 7.3 ONERING Card (optional)



The ONERING expansion card permits to connect up to 32 ONEMINI model panels. The purpose is to share information between panels, allowing also to do cross outputs activations. The ONERING card, is supplied with a flat cable and must be connected to the main board on connection J7 as shown below:

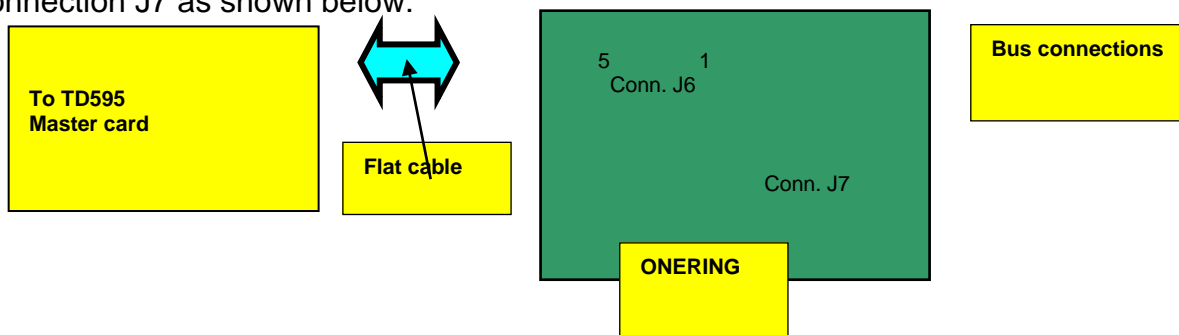

The control panel should be connected with cables with the following technical specifications:

- Use CAN bus cable with granted impedance 120Ω. (es. Belden 9842)
- Max distance at 50 kbit/s : 1000m

**Network cable characteristics**

LENGTH	TYPE OF CABLE
Up to 40mt	0.25-0.34mm <sup>2</sup>
Up to 300mt	0.34-0.6mm <sup>2</sup>
Up to 600mt	0.5-0.6mm <sup>2</sup>
Up to 1000mt	0.75-0.8mm <sup>2</sup>



With shielded and twisted 1mm<sup>2</sup> fire cable, maximum distance at 50Kbit/s speed is 400m.

ONERING expansion card installation is described below:

1. Turn off the panel, disconnecting the battery and removing the fuse.
2. Insert four 5mm M/F standoffs.
3. Assemble the ONERING card and fix it with four 3x6mm screws.
4. Connect the data flat cable in J7 connector of ONEMINI panel.
5. Connect the power cable to PSOUT+ and GND terminals of J4 connector of ONEMINI panel.
6. Turn on the panel, connecting the battery and inserting the fuse.

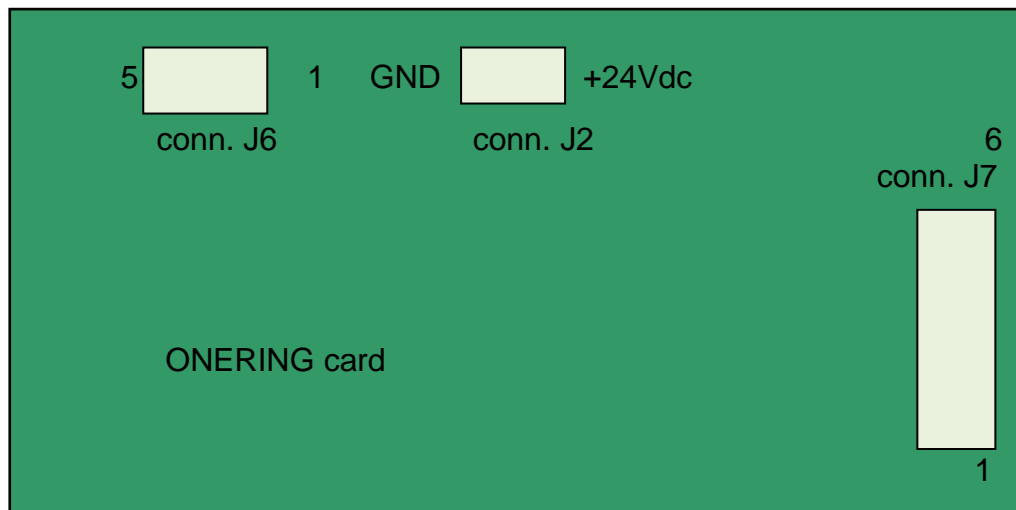

**J7 Connector on TD542/C ONERING card**

N. PIN	NAME	FUNCTIONALITY
1	CL side a	Bus L side A
2	CH side a	Bus H side A
3	Gnd/bus	Gnd bus ref.
4	Gnd/bus	Gnd bus ref.
5	CH side b	Bus H side B
6	CL side b	Bus L side B

**J2 Connector on TD542/C ONERING card**

N. PIN	NAME	FUNCTIONALITY
1	24Vdc	+ Power supply
2	GND	- Power supply

ONERING cards must be connected between each other as described below:

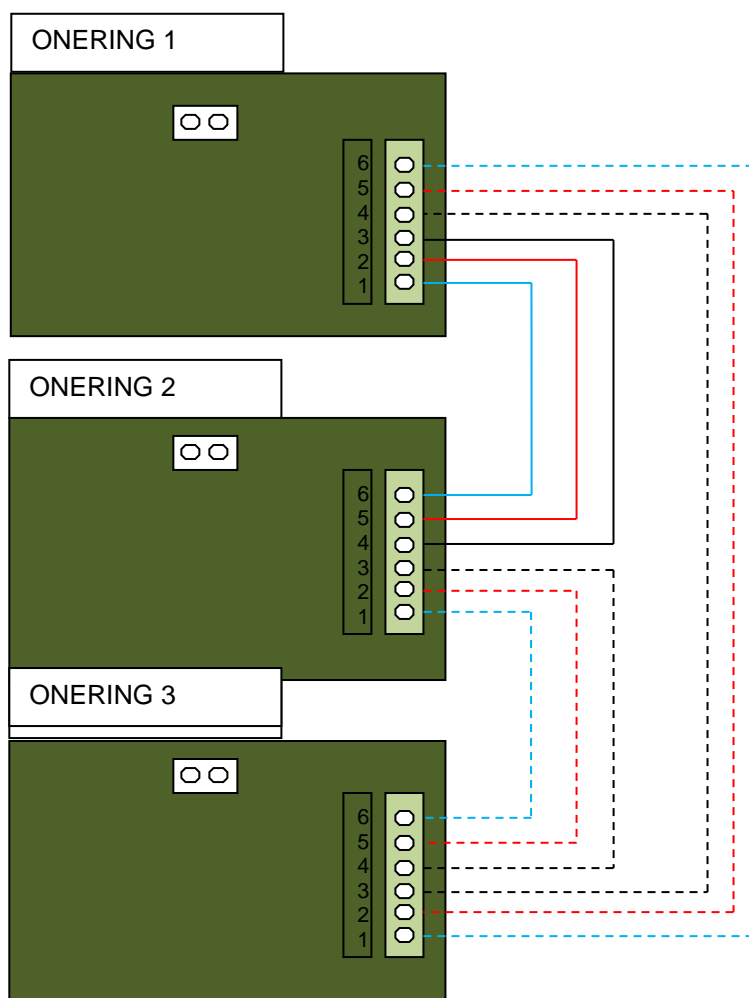

- CL A side of ONERING 1 to CL B side of ONERING 2
- CL A side of ONERING 2 to CL B side of ONERING 3, and so on until the ring is closed back to ONERING 1
- CH A side of ONERING 1 to CH B side of ONERING 2;
- CH A side of ONERING T 2 to CH B side of ONERING 3, and so on until the ring is closed back to ONERING 1.
- Connect also the ground bus (GND) between two consecutive ONERING cards

ONERING ring network is developed to ensure functionality also in case of a bus cut or short. The system is able to keep the data transfer between the panels in degraded mode, in case of power failure of one or more ONERING cards.



Check the bus connections before starting the system.

## 7.4 Power supplies and batteries

Inside ONEMINI panel it is possible to two 7.2Ah batteries.

Batteries must be cabled in series and blocked with the nylon wire wraps supplied.

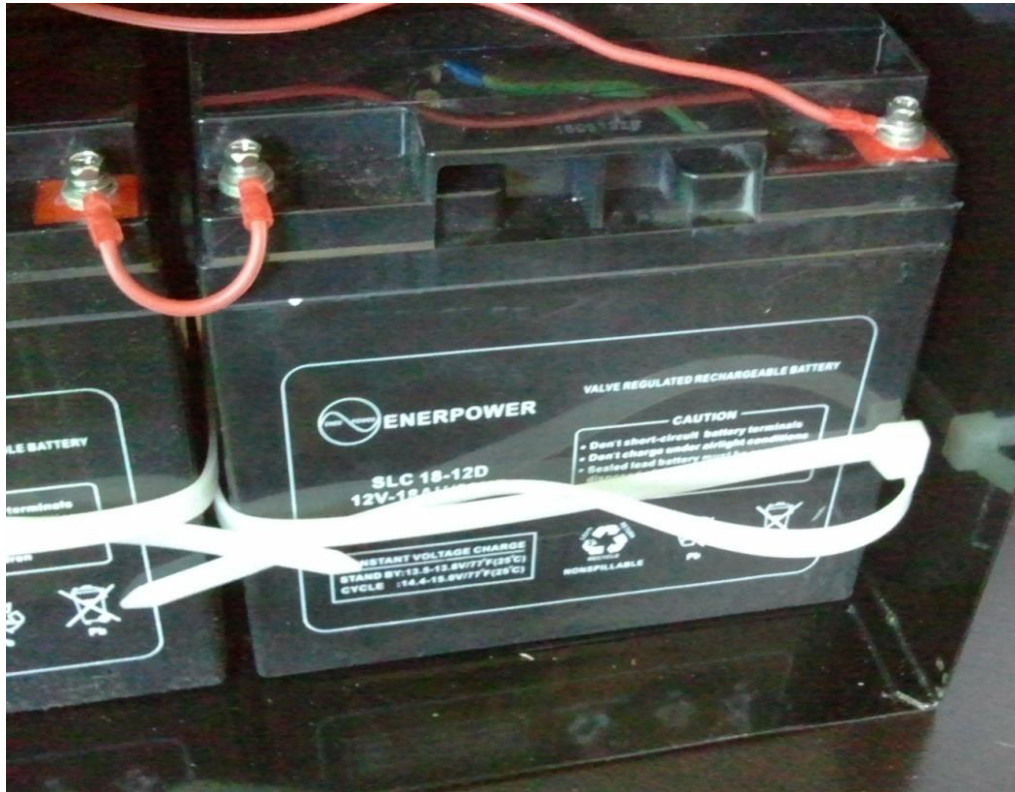

## 7.5 System description

Below is described a description of the control panel logic and of connections required to set-up the system.

### 7.5.1 Relations between the elements of the plant

The following picture shows the relations between the various elements that make up the plant managed by the control panel.

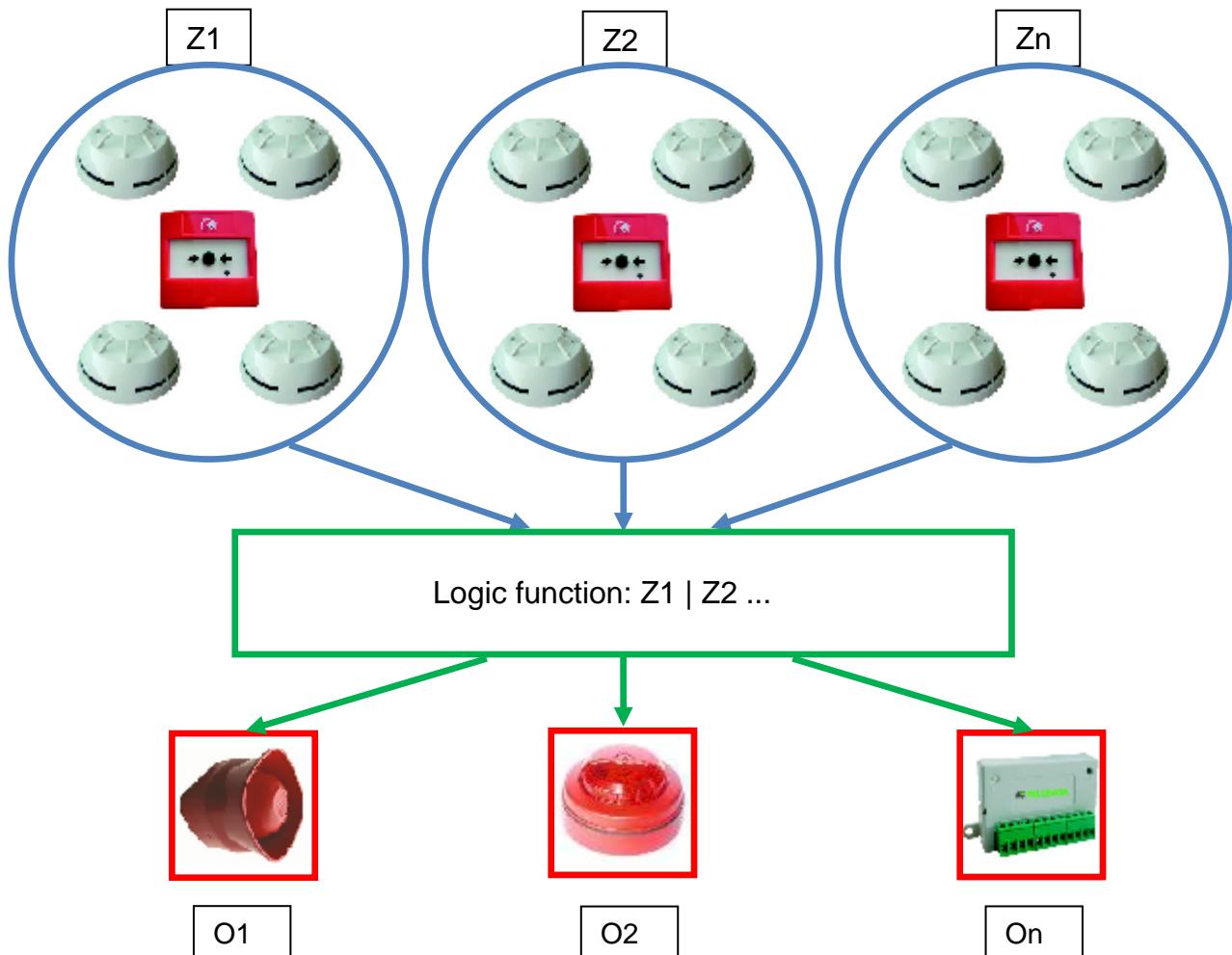

Devices (detectors, call points, etc.) are grouped in zones linked between them by specific logical functions that can activate one or more outputs.

### 7.5.2 Sounder and load connection

The outputs 5, 6,7,8 of the connector J12 are used to connect the loads (sounders, bells, optical acoustic displays) for which it is necessary to monitor the cut and the short.

The control panel is able to detect the presence of a cut or of a short circuit on the connection line of the loads. In the event of one of these cases the control panel will indicate it by an optical indication (message on the display, yellow LED for sounder fault is on) or acoustic signal (buzzer).



Follow the instructions below:

- Connect a 3.3kΩ ¼ Watt end of line resistor and a 1N4007 diode. Normally these resistors and diodes are provided with the control panel

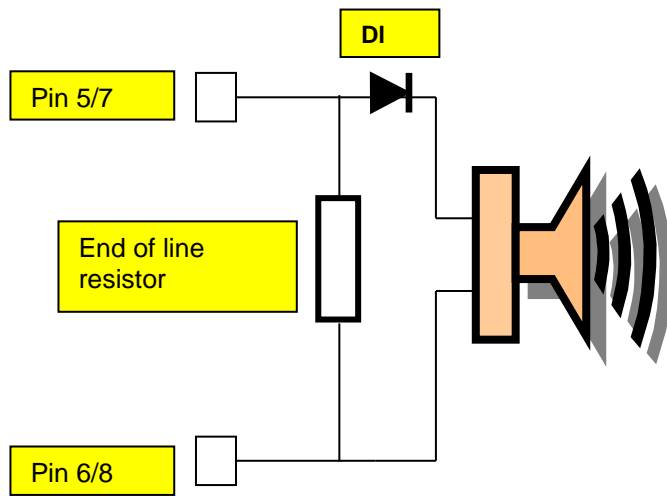

- Connect loads to the panel, use cables with a maximum resistance of 50 Ω.



The maximum current available is 1A @ 27Vdc.

The diagnostics of these outputs is activated only when the load is deactivated, that is when the control panel does not report any alarm.

If load is used with internal protection diode, such as optical acoustic displays protected against inversion, the protection diode may be omitted.

## 7.6 Communication with detectors and modules

The

ONEMINI control panel communicates with addressable detection and control devices through a two-wire line, called loop.

It is possible to use the control panel in open loop systems or closed loop systems.

According to the effective standards, in systems where there are more than 32 modules/detectors, it is necessary to use the closed loop configuration.

### 7.6.1 Open loop configuration

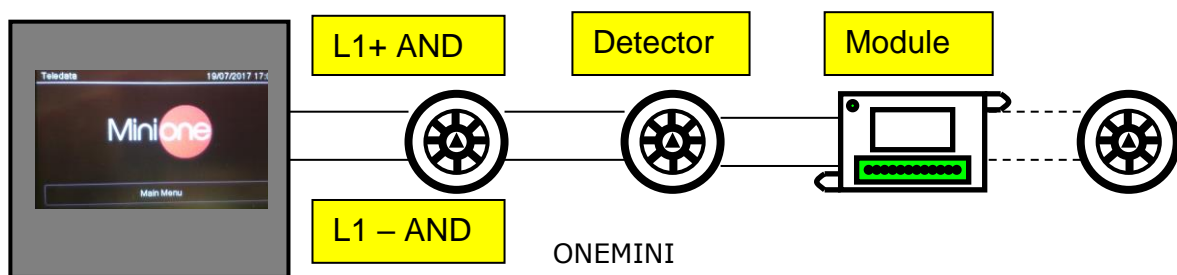

This configuration uses lines **L+** e **L-** on pins FW+ and FW-  
 It is possible to connect up to 32 detectors and I/O modules.

### 7.6.2 Generic loop connection requirements

Match the following requirements:

- Twisted and shielded 2-conductor cable,
- Loop with only detectors, call points and modules, total line length should not exceed:

LENGTH	TYPE OF CABLE
Up to 1250mt	2x0.5mm <sup>2</sup>
Up to 1850mt	2x0.75mm <sup>2</sup>
Up to 2500mt	2x1mm <sup>2</sup>
Up to 3500mt	2x1.5mm <sup>2</sup>
Up to 5000mt	2x2.5mm <sup>2</sup>

- Line resistance should not exceed 100Ω,
- Line cables installed on a dedicated path,
- Cables placed at a proper distance from the power lines.

### 7.6.3 Open loop configuration ("T" junctions)

Below an example of open loop configuration with "T" junctions.

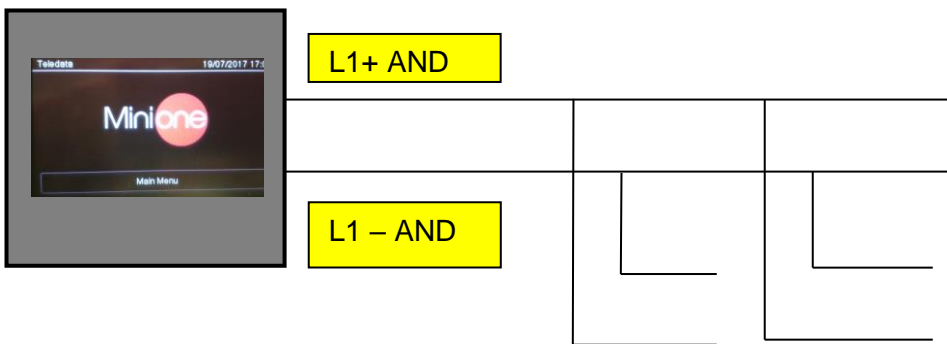

### 7.6.4 Open loop connection with "T" junctions connection requirements

Match the following requirements:

- The total length of all legs should not exceed the maximum allowed length, according to the section of the cable used,
- Total resistance from the control panel connectors to the end of every junction should not exceed 100Ω.

## 7.6.5 Closed loop configuration

Below an example of closed loop configuration.

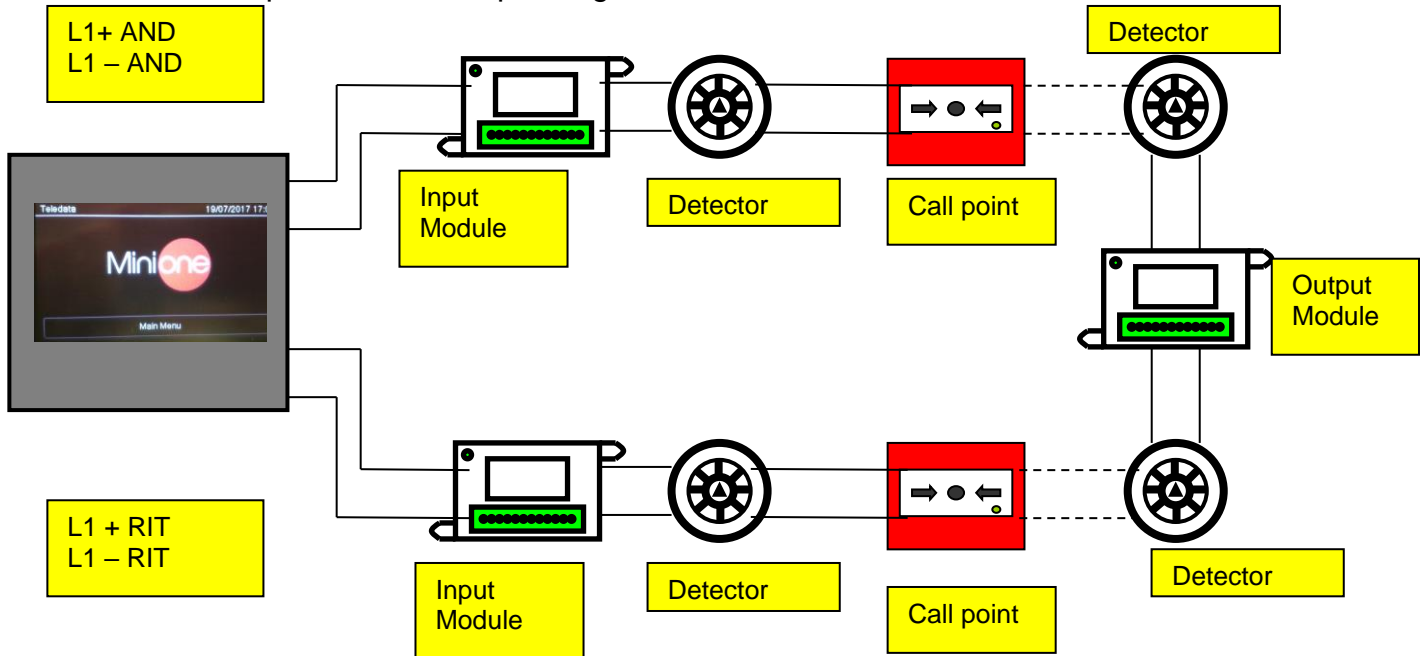

This type of configuration uses **L-** and **L+ FW** and **L-** and **L+ RET**

It is possible to connect up to 240 detectors and I/O modules.



If SFx000E type sensors are used, install an insulator module or sensor/module with on-board insulator for every 32 devices as required by current specifications.

## 7.6.6 Connection requirements for a closed loop connection

Match the following requirements:

- Total line length (between OUT and IN) should not exceed the maximum allowed length according to the section of the cable used.

## 7.6.7 Connectable loop devices

It is possible to connect the following ONE PROTOCOLL devices on the loop:

- ONEDETECTOR1 optical smoke detector
- ONEDETECTOR optical and rate of rise detector at 58 °C (class A1 and A1R)
- ONEDETECTOR2 temperature detector, (class A1R and B)
- ONECALLPOINT Addressable Manual call point
- ONEMODULE301 Addressable Module 3 inputs and 1 supervised output with short-circuit isolator
- ONEMODULE300 Addressable module 3 inputs with short circuit

- ONEMODULE111 Addressable Module 1 input 1 output form C 1 supervised output with short circuit isolator
- ONEMODULE120 Addressed module 1 input 2 output form C with short circuit isolator
- ONEMICROM10 Input micromodule with short circuit isolator
- ONEMICROM01 Output micromodule with short circuit isolator
- ONEMICROM11 Input and output micromodule with short circuit isolator
- SOUND100 Addressed siren EN 54 3 with short-circuit isolator
- SOUND101 Addressed siren EN 54 3 with flashing light and short-circuit isolator
- SOUND110 Siren addressed with flashing EN 54 3 and 23 and short-circuit isolator

All the above mentioned devices can be addressed by means of the appropriate programming tool **ONEPROGRAMMER**.

By means of the same tool it is also possible to read some basic parameters of the different devices.

For more information about this tool, please refer to its dedicated manual.

Follow the instructions below:

- All above mentioned devices are provided with an incorporated line insulator. This element, inside the devices, is connected to the line. It is therefore necessary to strictly observe the line wiring instructions (line-input, line-output) when any kind of device is going to be connected to the loop, as described in the data sheet attached to the device.
- It is necessary to strictly observe the instructions concerning the input/output loads connection described in the data sheet of all input/output devices (I/O modules)

It is possible to connect the following Argus's devices on the loop:

- BS5000 (40900) bases for SFx000 and SFx000E detector installation.
- SF5100 (40910-8) optical smoke detector
- SF5200 (40920-8) optical and rate of rise detector at 58 °C (class A1 and A1R)
- SF5300 (40930-8) temperature detector, (class A1R and B)
- SF5100E (IV100) (like SF5100 but without isolator)
- SF5200E (IV200) (like SF5200 but without isolator)
- SF5300E (LV350) (like SF5300 but without isolator)
- FDVCP500 (40800) call point
- FDMM10 (40100-m) supervised input module
- FDMM01S (40010-m) supervised output module
- FDMM02 (40002-m) form C output module
- FDS500 (40300) addressable sounder
- FDW2W transceiver for wireless devices

- FDMM12 (40102-m) Input/Output module
- FDMM11S (40110-m) supervised input/output module
- FDXMM11S (40110) supervised input/output module
- FDMC404 (40110) 4 input 4 output module
- FDMC602 (40602) 6 input 2 output module
- FDVCP500IP67 (40801) call point resettabile allarm
- FDCWS100AV Electronic sounder with addressable flashing
- FDVFI100 (40330) Addressable LED flashing
- FDVMCZ500 (40500) Remote addressed indicator
- FDVBS100/32 32 tone sounder
- SF100 Conventional optical detector
- SF200 Conventional optical and thermal smoke detector
- SF400 Conventional thermal smoke detector
- BSE100 conventional base
- BRL100 relè base

All the above mentioned devices can be addressed by means of the appropriate programming tool **FDVPU1000**.

By means of the same tool it is also possible to read some basic parameters of the different devices, and to program the type of functionality of the temperature detectors SF3500.

For more information about this tool, please refer to its dedicated manual.

Follow the instructions below:

- All above mentioned devices are provided with an incorporated line insulator. This element, inside the devices, is connected to the line. It is therefore necessary to strictly observe the line wiring instructions (line-input, line-output) when any kind of device is going to be connected to the loop, as described in the data sheet attached to the device.
- It is necessary to strictly observe the instructions concerning the input/output loads connection described in the data sheet of all input/output devices (I/O modules)

It is also possible to manage, by using FDW2W, the following wireless devices:

- SWF1000 optical smoke detector
- SWF2000 optical and rate of rise detector at 58 °C (class A1 and A1R)
- SWF3500 temperature detector, (class A1R and B)
- FDWVMI100 supervised input module
- FDWVMI120 output module
- FDWMCB100 battery powered output module
- FDSGLSP100 addressable sounder
- FDWCP100 call point

It's possible to connect the following Apollo's device on the loop:

<b>Apollo Code</b>	<b>Protocol</b>	<b>Device description</b>
<b>IN/OUT modules</b>		
55000-841	XP95	Modulo IN plus with input opto isolator
55000-843	XP95	IN Module
55000-847	XP95	IN/OUT Module
55000-849	XP95	Modulo OUT form C
55000-852	XP95	OUT Monitored Module
55000-845	XP95	Zone monitor alimented by Loop
55000-875	XP95	OUT Module form C
55000-760	XP95	Mini Switch Monitor
55000-589	XP95	IN/OUT module 3+3 without isolator
55000-588	XP95	IN/OUT Modulo 3+3 with isolator
55000-864	XP95	Zone monitor; alimentation by loop
<b>Detector</b>		
58000-600	Discovery	Optical detector Discovery
58000-700	Discovery	Multi Discovery
58000-400	Discovery	Temperature detector Discovery
58000-500	Discovery	Ion
55000-600	XP95	Optical detector XP95
55000-885	XP95	Multi XP95
55000-400	XP95	Temperature detector XP95 (55°)
55000-401	XP95	Temperature detector XP95 (90°)
55000-500	XP95	Ion
Call point		
55200-905	XP95	Call point XP95
58200-910	Discovery	Call point Discovery
SA5900-908	XP/Dis/Core	Call Point
<b>Bases</b>		
45681-210	NA	Normal addressable base
45681-284	NA	Base with isolator
<b>Audiovisual Discovery</b>		
58000-005	Discovery	Ottic and acustic sounder
45681-393	Discovery	Sounder beacon base
58000-010	Discovery	Voice alarm
45681-702	Discovery	Base sounder
<b>Audiovisual XP95</b>		
55000-001==>012	XP95	Open area alarm device
58000-700	XP95	Base sounder Discovery / XP95
45681-277	XP95	Integrated base sounder Discovery /XP95
55000-877	XP95	Loop powered beacon

45681-276	NA	Ancillary base sounder
<b>Soteria Detector</b>		
SA5100-400	Coreprotocol	Temperature detector
SA5100-600	Coreprotocol	Optical detector
SA5100-700	Coreprotocol	Multi criteria
	Coreprotocol	MCP
<b>Wireless XP95</b>		
XPA-CB-12034-APO	XP95	XPander Optical Smoke Detector
XPA_CB-13032-APO	XP95	XPander Multisensorr Detector
XPA-CB-11170-APO XPA-CB-11171-APO	XP95	XPander Heat Detector Rate-of-Rise (A1R) & Static (CS)
XPA-CB-14001-APO XPA-CB-14002-APO	XP95	XPander Sounder (red) & (white)
XPA-CB-14003-APO XPA-CB-14004-APO XPA-CB-14005-APO	XP95	XPndr Sounder Vis Ind (red) Sounder Base (red) XPndr Sounder Vis Ind (amber) and Sounder Base (white) XPndr Sounder Vis Ind (clear) and Sounder Base (white)
XPA-MC-14006-APO	XP95	XPander Manual Call Point
XPA-IN-14011-APO	XP95	XPander Input/Output Single Unit
XPA-IN-14012-APO	XP95	XPander Input/Output Dual Unit
XPA-IN-14050-APO	XP95	XPander Diversity Loop Interface Unit
55000-540	XP95	IS Ion detector
55000-640	XP95	IS Optical detector
55000-440	XP95	IS Heat detector
55200-940	XP95	IS MCP
Flame detectors	XP95	All flame detectors
55000-268/274	XP95	Beam detectors

## 7.7 Connection to host computer

The control panel can be connected to a host computer by means of a Point to Point connection or online by means of an appropriate LAN interface.

### 7.7.1 Point to Point connection

Below an example of point-to-point connection.

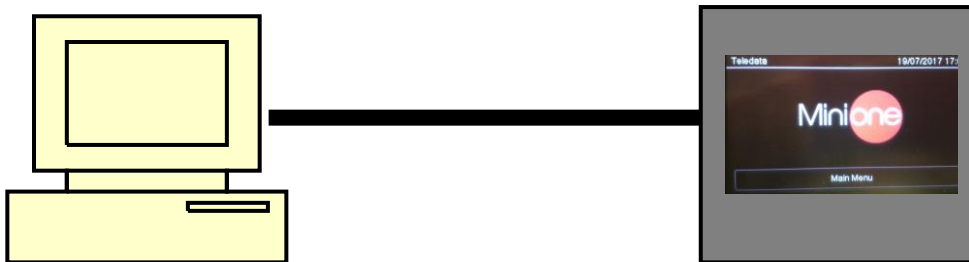

These types of configuration can be carried out through serial port that connect the host computer directly to the control panel through the connector P1. A connection label is provided below.

Connection:

Central Side	Connection	PC side
7 Jumpered with 8		7 Jumpered with 8
2	Connection with	2
3	Connection with	3
5	Connection with	5

It can be used for point-to-point connections with the program host to download a new firmware version.



### 7.7.2 LAN or WAN connection

Below an example of network connection.

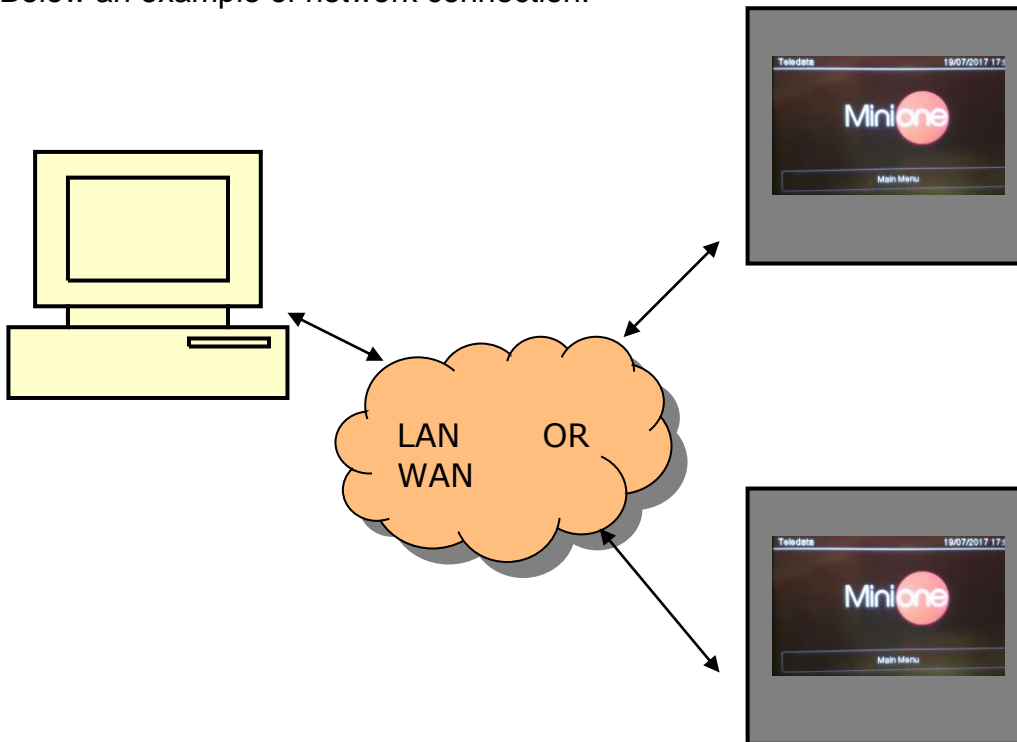

With this configuration it is possible to connect one or more control panel in a LAN or WAN environment and monitor them from a host provided with centralized supervision functionality.

### 7.7.3 ONEMINI control panel ring network

More than one ONEMINI control panel may be connected together in a ring network on a dedicated bus, by installing the optional ONERING network card.

In this network, events and alarms can be shared.

Below an example of ring network connection.

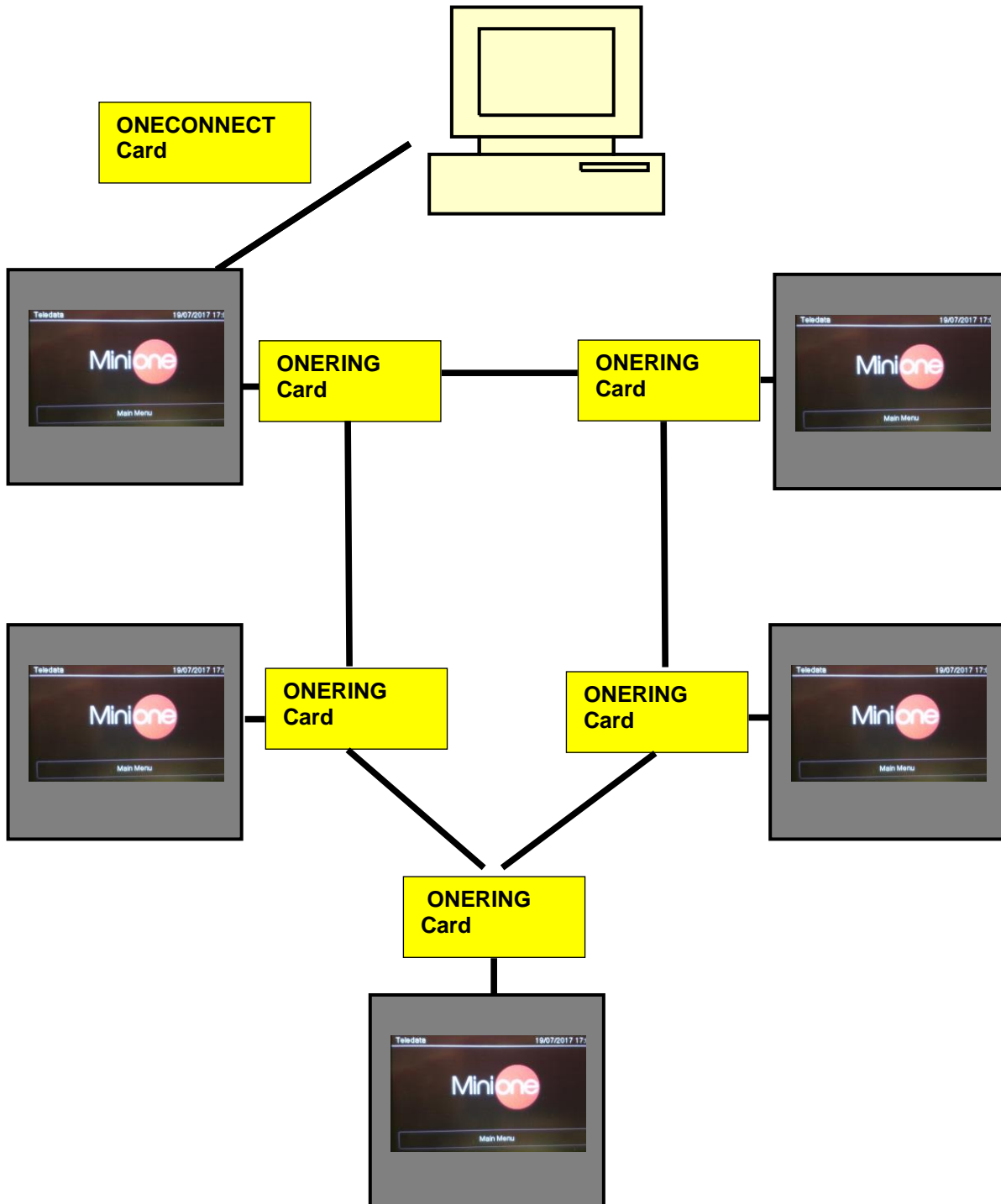

## 7.8 Power supply

### 7.8.1 Network input features

The control panel has to be installed according to the national installation standards.

It is requested to carry out a connection to a separated AC line that has to be marked with the label **FIRE SYSTEM**.

Use a double-pole switch minimum 6A.

The connection wires have to have a proper section area and a minimum insulation of **600V**.

The power supply input has to have the following features:

- Supply voltage 230 Vac +/- 10%
- Frequency 50/60 Hz

### 7.8.2 Grounding features

The grounding installation has to be carried out according to the CEI and ISPLES standards and with a resistance lower than **10Ω**.

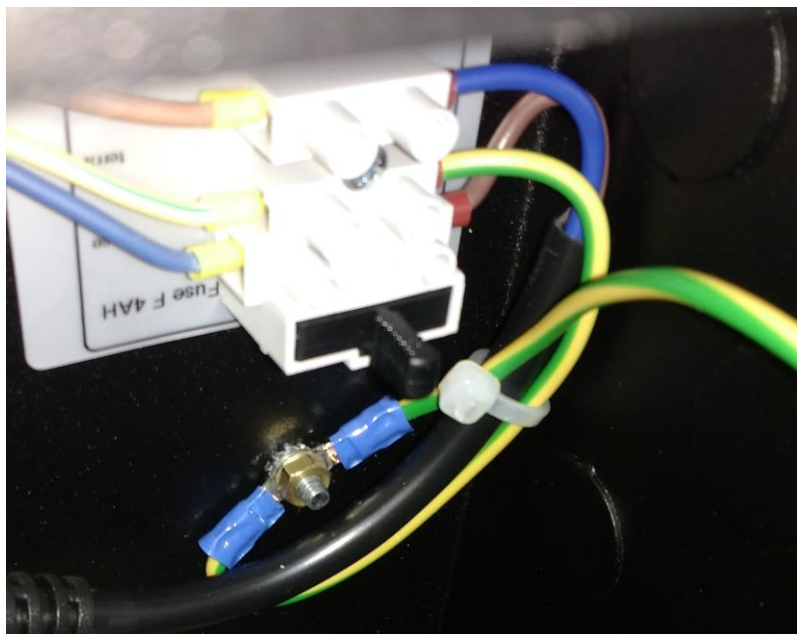

### 7.8.3 Panel power supply features

Following features are useful for the system installation:

- Output operating voltage 27.6 V - Max. 500mA
- Voltage of battery charger 27.6 V- Max. 900mA
- Low battery threshold 21.6 Volts
- Battery release threshold 20.4 Volts

The battery charger section works as follows:

- In case of power supply missing, the control panel is fed by the backup batteries. The green LED turns off.
- If the battery voltage drops below the low-battery threshold, an acoustic (buzzer) and visual (on-screen message) signal are activated
- In this situation, to restart the control panel, restore the network power supply.
- If no battery is installed, at the first battery control carried out periodically by the control panel, an acoustic (buzzer) and visual (on-screen message) signal are activated to signal that the batteries in the control panel are missing.
- If the battery's internal resistance (including the resistance due to contacts and cables) is higher than 800 mΩ, the control panel will emit an acoustic (buzzer) and optical (on-screen message) alarm.



The value of internal resistance is referred to 7,2Ah batteries.

As far as the operating +24 V power supply section for external loads is concerned:

- The voltage output is protected against short circuits.
- In case of a short circuit an acoustic (buzzer) and visual (on-screen message) signal is activated.

## 7.9 Panel internal cabling

The panel internal cabling has to be done in such way to be easily accessible in case of future maintenance.

The cables can enter into panel unit through the holes provided on the upper part of the box and on the back.

Cable outlet for 22 mm diameter must be use.

It is important to connect the cable shields to an earth terminal in the panel mechanics.

For closed loops, connect only one side of the shield, leaving the other side disconnected.

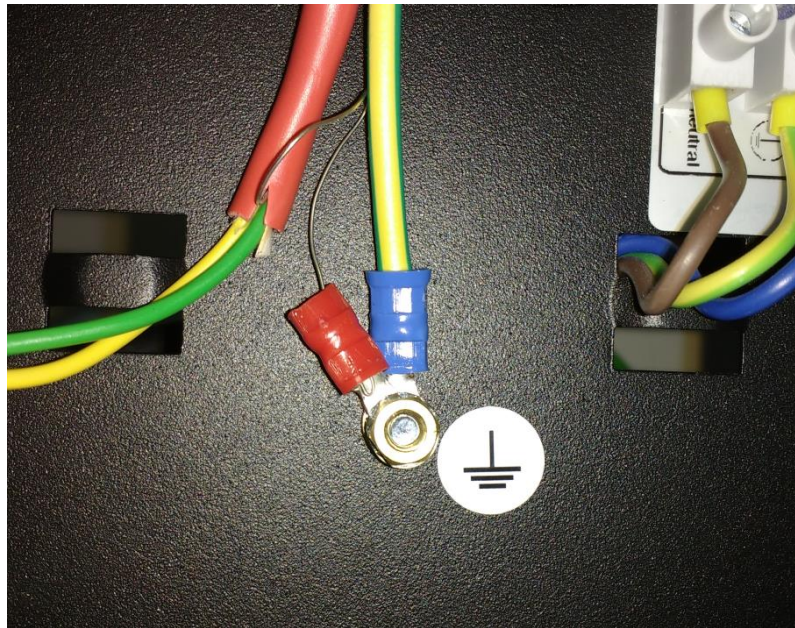

Below a cabling example of a complete panel is shown.



## 8. Control panel

The control panel includes the following elements:

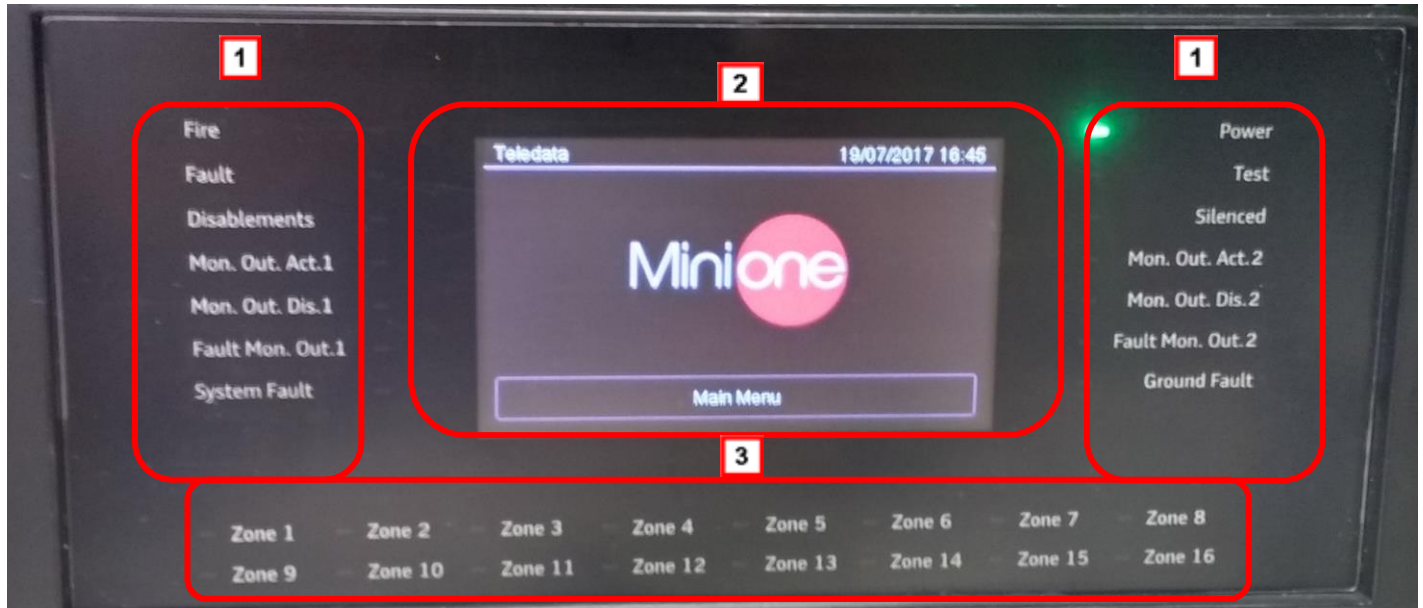

Area	Description
1	Status led
2	Graphic interface (touch screen)
3	Zone Led

### 8.1 Status led

The following led are on the control panel:

Name	Color	Description
Fire	Red	Fire alarm from at least a device in the system
Fault	Yellow	Generic fault
Disablements	Yellow	Devices or peripherals disabled
Mon. Out. Act.	Yellow	Monitored output activated
Mon Out. Dis.	Yellow	Monitored output disabled
Fault Mon. Out.	Yellow	Monitored output fault
CPU fault	Yellow	CPU fault
Power	Green	Main Power supply 220V
Test	Yellow	At least one device under test
Silenced	Yellow	Alarm silenced
Ext. Activation	Yellow	Extinguishing circuit activated (not yet available)
Ext. Release	Yellow	Extinguishing circuit released (not yet available)

Name	Color	Description
Ext. Out Serv.	Yellow	Extinguishing circuit fault (not yet available)
Ext. Locked	Yellow	Extinguishing circuit locked (not yet available)

## 8.2 Graphic interface

The following elements are always displayed in all menus:

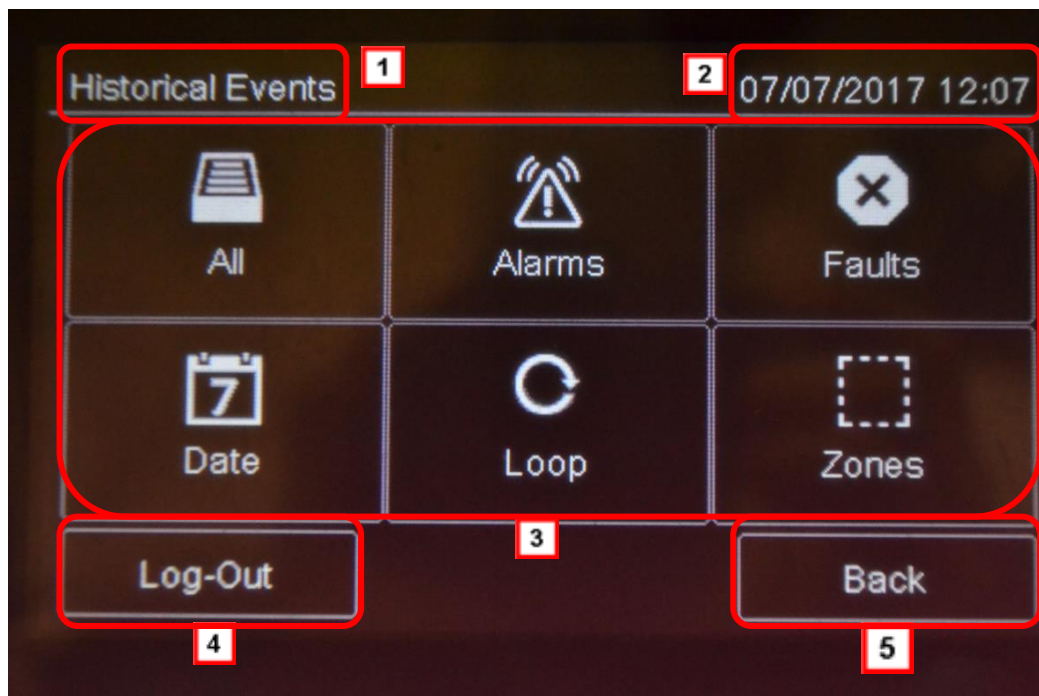

Area	Description
1	Page name
2	Unit date and time
3	Specific page content
4	Exit key
5	Back key

## 8.3 Types of users

The panel can be used by three different types of users:

- **User** that can:
  - view system events
  - silence the panel and alarms
  - reset the panel and alarms
  - disable devices
  - test installed devices
  - export log events to USB

- device diagnostics
- **Programmer** that can:
  - configure and initialize the unit
  - view system events
  - disable devices
  - test installed devices
  - add and configure new devices
- **Technical support** that can:
  - carry out all operations reserved to Technical support personnel.

Each operator can only open the screens required to run their permitted operations.

Any operator can view the system status and current events because these operations are directly accessible from the Main page which is not password protected.

## 8.4 Access levels

As described by EN54/2, there are four access levels to the control panel:

- **Level 1:** no access code is required
- **Level 2:** reserved to *Users* (up to maximum three operators); an access code is required
- **Level 3:** reserved to *Programmers*; an access code is required (and jumper JP3 must be closed)
- **Level 4:** reserved to *Technical support*; a wired PC connection is required.



## 9. Basic operations for any operator

### 9.1 View basic information

The home page is viewed when turned on if no events have occurred:



Press **Main Menu** to view it:

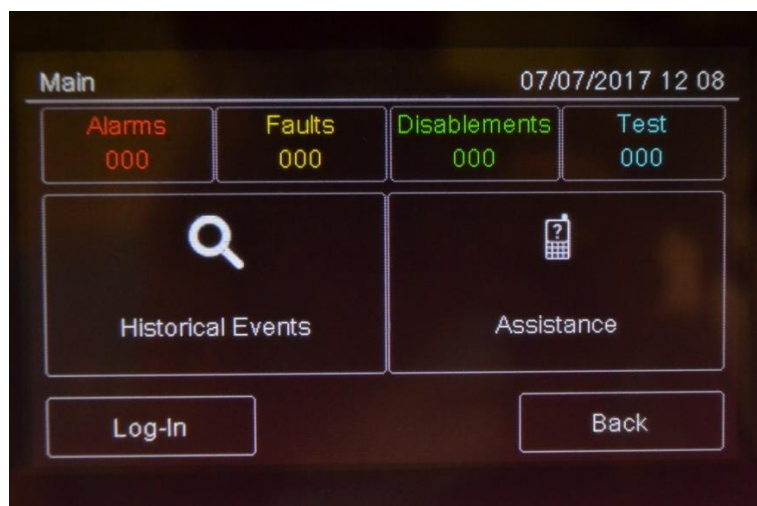

The menus in this page can be opened without entering any code.

#### *Options*

Menu	Function
<b>Events</b>	Opens the Events menu.
<b>Assistance</b>	Opens the Assistance page.

If any type of event has occurred, the **Current events** page is displayed when turned on.



**Fields**

Field	Description
<b>Alarms</b>	Displays the number of devices in alarm.
<b>Faults</b>	Displays the number of devices in fault status.
<b>Exclusion</b>	Displays the number of devices disabled.
<b>Test</b>	Displays the number of devices under test.

**Options**

Option	Function
<b>Log – in</b>	To open unit functions with a login code.
<b>&lt; &gt;</b>	To scroll through the pages that display all events.
<b>Silence</b>	To mute the panel buzzer (but not device alarms).

**9.1.1 Viewing events**

Main menu -> Events

The **Events** menu lets you view events logged by category.

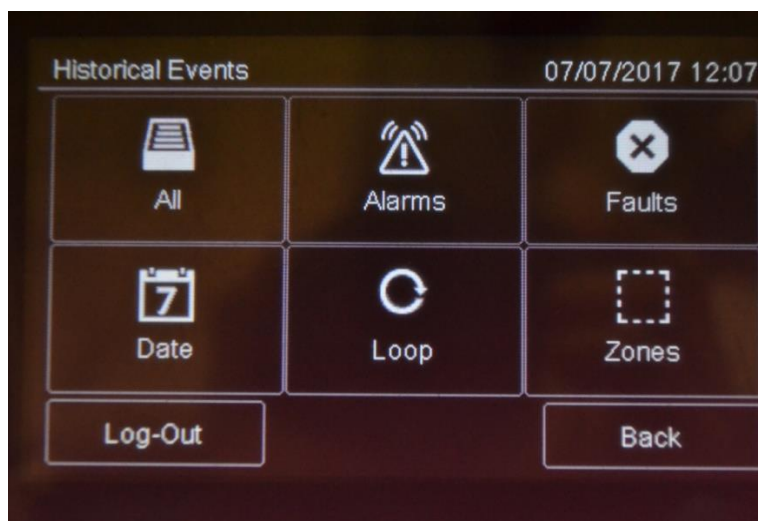

## Procedures

### To view all events:

- Select **All**: a list of all events is displayed.

### To view all alarms:

- Select **Alarms**: a list of all alarms is displayed.

### To view all faults:

- Select **Faults**: a list of all faults is displayed.

### To view events on a specific day:

- Select **Date**: the **Log by Date** screen appears.
- Set the date of the events to be viewed.
- Press **Save** to confirm: all events on the selected day are displayed.

### To view events in a specific loop:

- Select **Loop**: the **Log by Loop** screen appears.
- Select the loop of the events to be viewed.
- Press **Save** to confirm: all events in the selected loop are displayed.

### To view events in a specific zone:

- Select **Zone**: the **Log by Zone** screen appears.
- Select the zone of the events to be viewed.
- Press **Save** to confirm: all events in the selected zone are displayed.

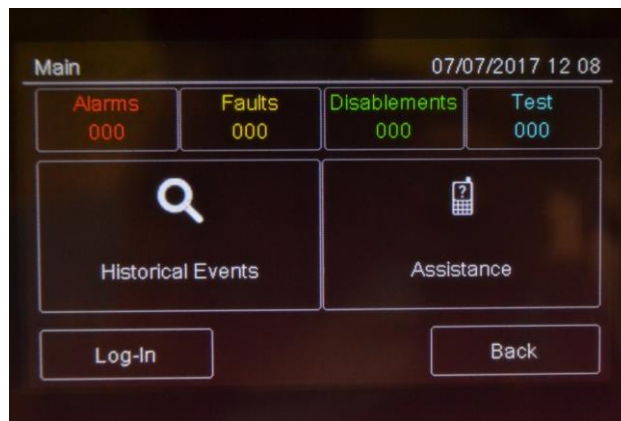

:it's possible to enter in Events menu choosing one of the box show in main page; we can only see the events related to the events choose.

## 9.1.2 Viewing assistance information

Main menu -> Assistance 

Information required to receive assistance is displayed in this page.

## 9.2 Login

Main page -> Log-in

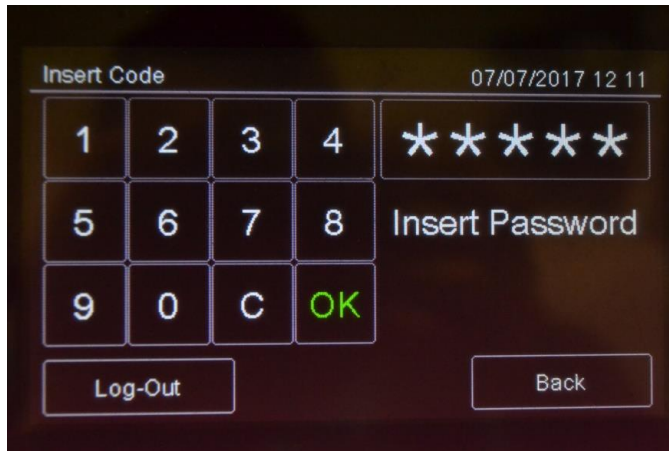

### Default settings

The following codes are set by default:

- **User code:** 22222, 22223, 22224
- **Programmer code:** 33333



Default user profile passwords 22223 and 22224 are disabled. For instructions on how to enable them, see *Enabling users and changing login codes*).

### Procedure

1. Insert the five digits of the code.
2. Press **OK** to confirm: the relevant menu is displayed according to the entered code.



Change the password as soon as possible to avoid unauthorized access to the system (see *11.2 Enabling users and changing login codes*).

### User menu

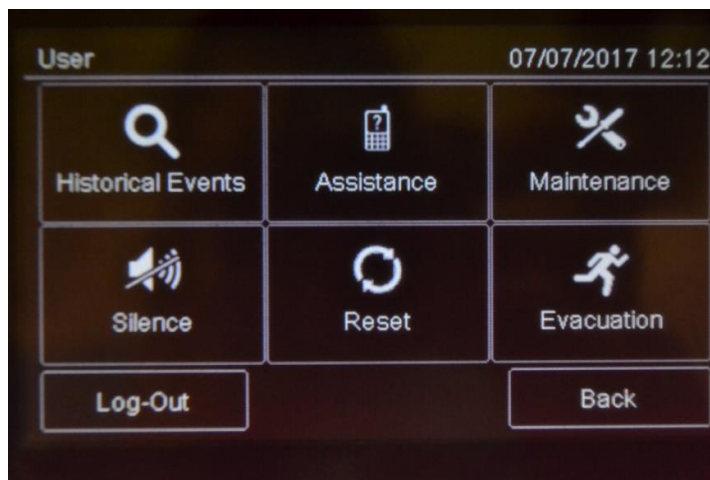

## Programming menu

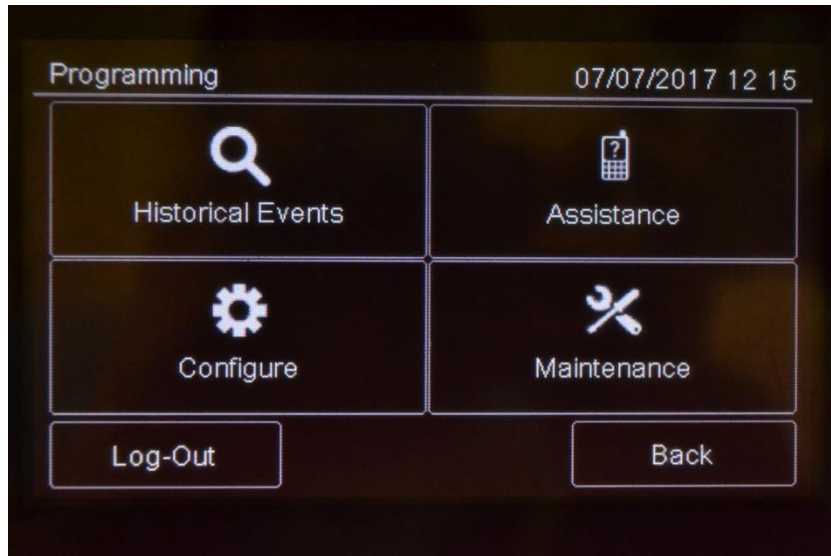

Procedures used by the various operators who work on the unit are described below.



This icon identifies functions reserved to the User.



This icon identifies functions reserved to the Programmer.

# 10. Configuration



The functions described below can only be run by authorized operators who have a specific system login code to the task to be performed.

## 10.1 Setting up the panel



The following functions are reserved to the Programmer.

To set up the panel after installation:

- set the number of installed expansion boards,
- set device addresses,
- set connected device names and features,
- group devices in zones,
- set relations between zones,
- create logic functions to turn on outputs,
- set output activation,
- set the calendar.



### 10.1.1 Progr. Menu -> Configure -> System -> Additional Cards -> Onering

This function allows to configure all the necessary parameters for the correct functionality of the ONERING system. In order to have this functionality, it is necessary to have installed in the panel an OneRing additional card, and the panel is connected into a ring with other ONEMINI

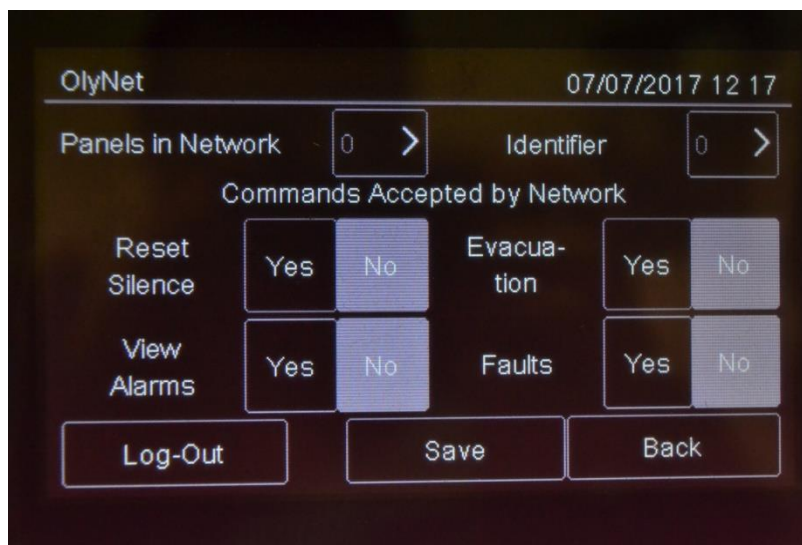

#### Procedura

1. Select the quantity of panels connected into the ring.
2. Select the single panel and confirm the model and the quantity of loops used.

3. Set the ID of the panel being configured.
4. Set the commands accepted from the network.
5. Press **Save** to confirm.

### 10.1.2 Run auto-addressing



Programming menu -> Configure -> Auto Addr.

This function will automatically set an address to all devices connected to the panel, without using the hand programmer.

### 10.1.3 Run self-programming



Programming menu -> Configure -> Auto Progr.

This function will search for and save all devices connected to the panel.

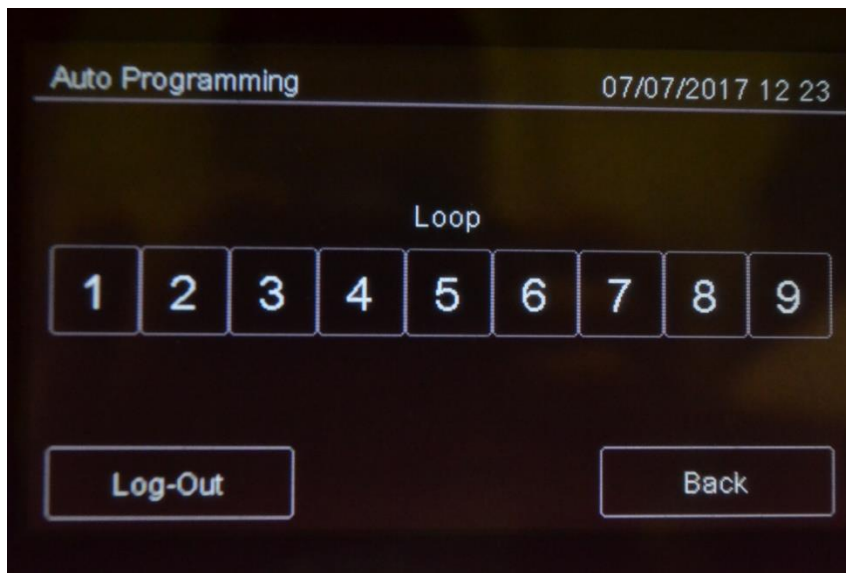

#### *Procedure*

Select the required loop: self-programming will start and the found devices will be displayed as illustrated in the example.

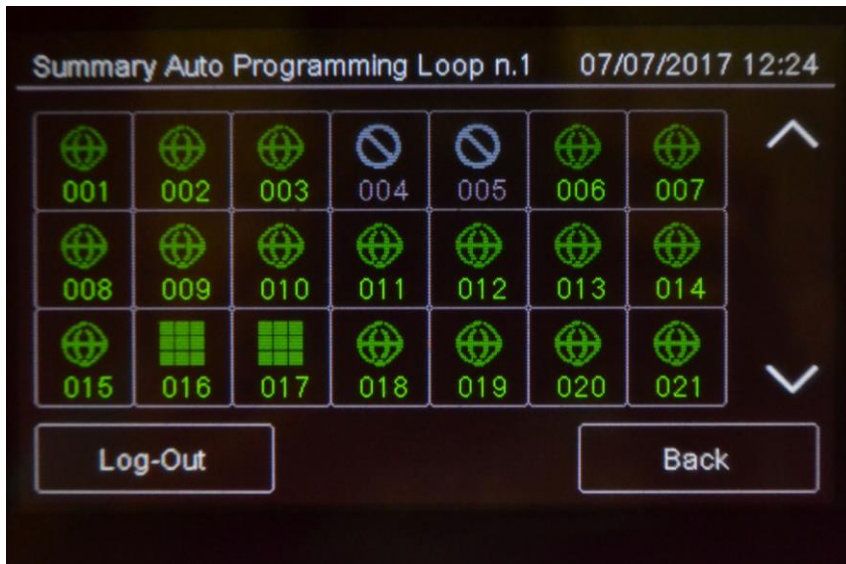

## 10.2 All In All Out configuration

### Programming menu -> Configure -> Devices/Zones -> All In All Out

This is a security mode feature that permit to have activation of all the outputs before to finish causes and effects configuration.

By default All In All Out set is enable, so at the first input alarm, all output will be activated.

When program is completed and checked, this set can be changed on disabled.

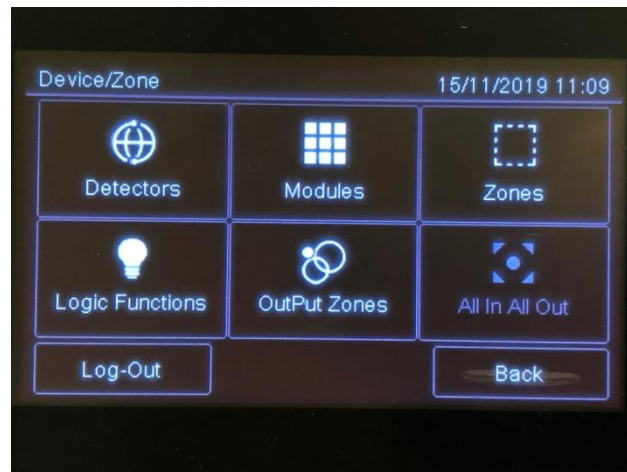

When general setting of this parameter is changed , all outputs follow this status



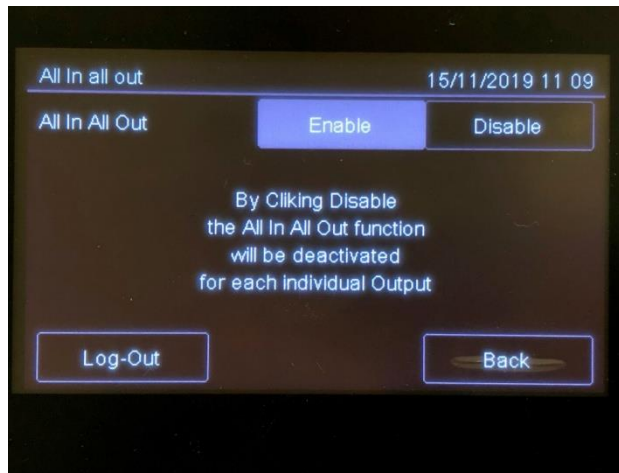

It's possible to activate for single output device this functionality. ( see 10.4)

### 10.3 Detectors configuration



The following functions are reserved to the Programmer.



**Programming menu -> Configure -> Devices/Zones -> Detectors**

With this function it is possible to:

- add a detector
- edit an already added detector
- copy a detector settings to one or more consecutive detectors
- delete a detector

#### Settings

Detector parameters to be set are described below.

Parameter	Description
<b>Name</b>	Detector identification name
<b>Type</b>	Type of connected detector (Optical, Thermal, Optical/Thermal)
<b>Radio</b>	Identifies wireless devices. With wireless devices, an FDW2W wireless translator must be installed.
<b>Verify Alarms</b>	Enables an alarm verification procedure, for an amount of time that can be programmed using parameter <b>Verify seconds</b> .
<b>Verify seconds</b>	Interval, in seconds, during which the detector has to remain in alarm before the panel will display the fire alarm. If set to zero, the panel will go to alarm status only when it receives three consecutive alarms from the detector within 60 seconds from the arrival of the first one. The first two alarms received will be ignored by the panel and will reset the detector.

<b>Slave sounder</b>	<p>This setting change led remote output of detector to work as output of panel. If this is set as YES follow settings compare:</p> <p><b>Activate Evacuation:</b> This output follow Evacuation command  <b>All In All Out:</b> This output follow AIAO security activation mode  <b>Silenceable:</b> This Output follow out silence / rearm command</p>
<b>Sensitivity management</b> (only for smoke detectors)	<p><b>24 H:</b> the level of sensitivity remains the set one for the entire day.  <b>Night:</b> sensitivity increases by one step during the night.  <b>Fixed:</b> fixed sensitivity set to Medium High.</p> <p>If the <b>Night</b> management is selected, it is also necessary to set the <b>Weekly Trend</b> parameter.</p>
<b>Sensitivity</b>	Detector level of sensitivity (Low, Medium Low, Medium High, High)
<b>Deactivate part</b> (only for multi detector)	<p><b>Day:</b> select the part to deactivate it (smoke or thermal)  <b>Night:</b> select the part to deactivate it (smoke or thermal)</p> <p>If this feature is used, it is also necessary to set the <b>Weekly Trend</b> parameter.</p>
<b>Weekly trend</b>	Sets the weekly trend for the deactivation of part of the detector. (see <i>10.8.5 Setting weekly trends</i> ).

### Procedures

#### To add a sensor:

1. Select the **Add** option: a list of loops in the system is displayed.
2. Select the loop where the sensor has to be added: a list of sensors in the loop is displayed.
3. Select an unused sensor number: the sensor settings window is displayed.
4. Enter the required settings.
5. Press **Next** to move to the next screen.
6. Press **Save** to confirm.

**To edit a sensor:**

1. Select the **Edit** option: a list of loops in the system is displayed.
2. Select the loop that contains the sensor.
3. Select the required sensor.
4. Edit settings.
5. Press **Save** to confirm.

**To delete a sensor:**

1. Select the **Delete** option: a list of loops in the system is displayed.
2. Select the loop that contains the sensor.
3. To delete a single sensor, press the sensor twice.
4. To delete several consecutive sensors, press the first and last module in the interval.
5. Press **Save** to delete the sensor or sensors.

**To copy a sensor:**

1. Select the **Copy** option: a list of loops in the system is displayed.
2. Select the loop that contains the sensor to be copied
3. Select the sensor to copy settings from.
4. Select the first sensor in the group to copy settings to.
5. Select the last sensor in the group to copy settings to.
6. Press **Save** to apply settings to all selected sensors.

## 10.4 Modules configuration



The following functions are reserved to the Programmer.



**Programming menu -> Configure -> Devices/Zones -> Modules**

This function lets you:

- add a module
- edit an already added module
- copy a module settings to one or more consecutive modules
- delete a module

### Settings

Following are the parameters to be set for all types of modules.

Parameter	Description
<b>Name</b>	Module identification name
<b>Radio</b>	Identifies wireless devices. With wireless devices, a FDW2W wireless converter must be installed.
<b>Type</b>	Module type: Argus:(Input, Output, Expander); Apollo: (input, output, expander ,multi 1+1, multi 2+2, multi 3+3)

Following are the parameters to be set for an **Input** type module.

Parameter	Description
<b>Type</b>	Module type (Input, Call point Gas)
<b>Alarm test</b>	Enables an alarm verification procedure, for an amount of time that can be programmed using parameter <b>Verify seconds</b> .
<b>Test seconds</b>	Interval, in seconds, during which the detector has to remain in alarm before the panel will displayed the fire alarm. If set to zero, the panel will go to alarm status only when it receives three consecutive alarms from the detector within 60 seconds from the arrival of the first one. The first two alarms received will be ignores by the panel and will resets the detector.
<b>Strength alarm</b>	This setting give to input to be able to reset T1 and T2 timer for protected or not protected mode of the zones and activate outputs
<b>Technological</b>	Identifies the alarm signal as "technological" and thus less critical. Setting a module like technologic, it's possible setting other 3 functions: Fault, Self Restore and Pre-Alarm
<b>Fault</b>	Event to control is interpreted from panel as fault and for that is managed. It is shown in the display Fault-Technology that has occurred on the programmed module.
<b>Self restore</b>	This function allows the automatic reset of the central once the 'input falls in the stand-by condition. It is activated in case of technological monitoring or fault.
<b>Pre-alarm</b>	Turns on the pre-alarm function

Parameter	Description
	When a pre-alarm event is detected: all output modules associated with the output zones where the pre-alarm was triggered are turned on (see 10.6 Output zones), the unit red led blinks, if the pre-alarm is not reset during the pre-alarm time or an alarm triggers, the panel red led turns on.

Following are the parameters to be set for an **Output** type module.

Parameter	Description
<b>Type</b>	Module type (Output, Flasher, Siren, Repeater LED).
<b>Reset sensors</b>	This feature is usually used to reset conventional devices that are not connected directly to the loop. Every time that the panel is reset, this output will be activated for around 5 seconds.
<b>All In All Out:</b>	This output follow AIAO security activation mode
<b>Silenceable</b>	This Output follow out silence / rearm command
<b>Activate Evacuation</b>	If activated, this feature will activate the output in case of an user evacuation command, also if its zone or the logic function where it is linked is not yet valid.
For <b>Siren</b> type modules only	
<b>Volume</b>	(only for siren model FDVBS100/32 or FDVBS100-AV/32) Siren volume level, also set the tone.

Di seguito I parametri da impostare per configurare moduli di tipo Multi I/O

Parameter	Description
<b>Type</b>	Module type (Multi I/O 1+1, Multi I/O 2+2, Multi I/O 3+3).
<b>Choose device</b>	This function is used to set devices for each line of input and output from the form: we will have two devices (one inbound and one outbound) if the Multi I / O is 1 + 1, 4 devices (two input and two outgoing) if the Multi I / O is 2 + 2, finally 6 devices (three input and three output) if the Multi I / O is 3 + 3.
<b>Input type</b>	Type of input module that can be inserted (input, throttle button)
<b>Output type</b>	Type of output module that can be inserted (output, flash, siren, led.rip.)

*: it is important to remember that multiple modules occupy multiple addresses, depending on whether 1 + 1, 2 + 2 or 3 + 3; this because the input / output occupy additional subsequent virtual address to the address of the physical module.*

### Procedures

**To add a module:**

1. Select the **Add** option: a list of loops in the system is displayed.
2. Select the loop where the module is to be added: a list of all devices in use, both modules and sensors, in the loop is displayed.
3. Select an unused module number (blank): the module settings window is displayed.
4. Enter the required settings.
5. Press **Next** to move to the next screen.
6. Press **Save** to confirm.

#### **To edit a module:**

1. Select the **Edit** option: a list of loops in the system is displayed.
2. Select the loop that contains the module.
3. Select the required module.
4. Edit settings.
5. Press **Save** to confirm.

#### **To delete a module:**

1. Select the **Delete** option: a list of loops in the system is displayed.
2. Select the loop that contains the module.
3. To delete a single module, press the module twice.
4. To delete several consecutive modules, press the first and last module in the interval.
5. Press **Save** to delete the module or modules.

#### **To copy a module:**

This function lets you apply settings for one module to several consecutive modules:

1. Select the **Copy** option: a list of loops in the system is displayed.
2. Select the loop that contains the module to be copied
3. Select the module to copy settings from.
4. Select the first module in the group to copy settings to.
5. Select the last module in the group to copy settings to.
6. Press **Save** to apply settings to all selected modules

## 10.5 Zones configuration



The following functions are reserved to the Programmer.



Tip: before starting these operations, make sure you have understood how the various system elements interact. See *7.5.1 Relations between the elements of the plant.*

### 10.5.1 Programming menu -> Configure -> Devices/Zones -> Zones

A zone is a list of devices and events that are necessary to generate partitions of the system. It is possible to link devices, loops, and events to a zone.

This function lets you:

- link events, loops and devices to the the zones
- set various zone operating parameters
- link output modules to a zone

### 10.5.2 Link an event to a zoneSettings

Settings are described below.

Parameter	Description
<b>Alarm</b>	The zone is activated by an alarm of the linked devices.
<b>Fault</b>	The zone is activated by a fault of the linked devices.
<b>Technol.</b>	The zone is activated by a "technological" event of the linked devices.
<b>Coincidence</b>	Programmable by event, this parameter is the number of events that have to be recorded in order to activate the zone.

#### *Procedure*

1. Select the **Add** option: a list of zones in the system is displayed.
2. Select the required zone.
3. Select the **Events** option.
4. Select the events and their coincidence to be linked to the zone.
5. Press **Save** to confirm.

### 10.5.3 Linking loops to zones

#### *Settings*

Settings are described below.

Parameter	Description
<b>All system</b>	If <b>Yes</b> , all system devices will be linked to the zone. If <b>No</b> , select the loop that activates the zone.
<b>Loop</b>	Select the entire loop that will be associated with the programmed zone.

### *Procedure*

1. Select the **Add** option: a list of zones in the system is displayed.
2. Select the required zone.
3. Select the **Loop** option.
4. Set the required parameters:
5. Press **Save** to confirm.

## **10.5.4 Linking devices to zones**

### *Procedure*

1. Select the **Add** option: a list of zones in the system is displayed.
2. Select the required zone.
3. Select the **Device** option.
4. Select the required loop: all devices in the loop are displayed.
5. Select all devices to be linked to the zone.  
( A device can be added to 12 different zones at the same time)
6. Press **Back** to save the selection.



## 10.5.5 Set zone operating parameters

This function lets you set weekly zone behavior. This is helpful to bypass the unit on certain days or at certain times.

### Settings

Settings are described below.

Parameter	Description
<b>Zone name</b>	Name assigned to the zone
<b>Weekly trend Autoexclusion</b>	Weekly trend linked to the zone. (see 10.8.5 Setting weekly trends).
<b>protected</b>	If set to Yes, you can set the times T1, T2, T2B and set the weekly survey of trends.
<b>T1</b>	It is the warning phase; in the moment of its activation, the area is already in alarm but the associated output are still not parties.
<b>T2</b>	And the investigation time to physically check the veracity alarm; T2B has the same operation, but only if the warning comes from a button.
<b>weekly trend survey</b>	By setting this parameter, you can program the zone protected or unprotected during the week.

### Procedure

1. Select the **Add** option: a list of zones in the system is displayed.
2. Select the required zone.
3. Select the **Settings** option.
4. Enter the required settings.
5. Press **Save** to confirm.

To verify that a zone is properly set as **protected**, also follow the following procedure:

1. Enter third level code 33333;
2. Select the Configure section;
3. Enter the System section;
4. Press the General Section;
5. Enter the Various section;
6. Verify that The terminals T1 and T2 are enabled; (Section 10.7.10 of this manual)
7. Perform the Log-Out;
8. Enter the second level code 22222;
9. Select the Maintenance section;
10. Select the Exclusions section;
11. Entering the section **protected**;
12. Verify that the area we have planned as **protected** is green

## 10.5.6 Link an output module to a zone

This function lets you directly link output modules to a zone. When the zone is triggered, the output modules automatically turn on.

The maximum number of outputs that can be added on a Zone is 60

### *Procedures*

#### **To add a zone:**

1. Select the **Add** option: a list of zones in the system is displayed.
2. Select the required zone.
3. Select the **Output Modules** option.
4. Select the output module loop.
5. Select the required module.
6. Set the required parameters:
7. Press **Save** to confirm.

#### **To edit a zone:**

1. Select the **Edit** option: a list of zones in the system is displayed.
2. Select the zone to be edited.
3. To edit linked events see *10.5.2 Link an event to a zone* for parameter descriptions.
4. To edit linked loops: see *10.5.3 Linking loops to zones* for parameter descriptions.
5. To edit linked devices see *10.5.4 Linking devices to zones* for parameter descriptions.
6. To edit operating parameters: see *10.5.5*

*Set zone operating* parameters for parameter descriptions.

7. To edit output modules: see *10.5.6 Link an output module to a zone* for parameter descriptions.

**To delete a zone:**

1. Select the **Delete** option: a list of zones in the system is displayed.
2. Select the zone to be deleted
3. To delete a single zone, press the zone twice.
4. To delete several consecutive zones, press the first and last zone in the interval.
5. Press **Save** to delete the zone.

## 10.6 Output zones configuration



The following functions are reserved to the Programmer.



**Programming menu -> Configure -> Devices/Zones -> Output Zones**

This function lets you link output modules to output zones.

### *Settings*

Settings are described below.

Parameter	Description
<b>Activations</b>	Event type that activates the zone (Alarm, Pre-alarm Gas)

### *Procedures*

#### **To create an output zone:**

1. Select the **Add** option: a list of output zones in the system is displayed.
2. Select the first available output zone.
3. Set the required parameters:
4. Press **Next** to continue.
5. Select the loop that includes the output module to be linked.
6. Select the output module to be linked to the output zone.
7. Press **Save** to confirm.

#### **To edit an output zone:**

1. Select the **Edit** option: a list of output zones in the system is displayed.
2. Select the output zone to be edited.
3. Edit settings.
4. for parameter descriptions.
5. Press **Save** to confirm.

#### **To delete an output zone:**

1. Select the **Delete** option: a list of output zones in the system is displayed.
2. Select the output zone to be deleted
3. Press **Save** to delete the output zone.

## 10.7 Logic functions configuration



The following functions are reserved to the Programmer.



**Programming menu -> Configure -> Devices/Zones -> Logic functions**

Logic functions are cause and effect relations between events that occur in the panel. Logic functions can put the following into relation:

- detectors
- modules
- zones
- alarms coming from the Onering system
- events (not yet available)
- logic functions

For example, you can create a logic function in which the activation of a series of zones (inputs) activates specific outputs.

### *Logic operators*

It is possible to link various inputs by using these logic operators:

- AND
- OR
- NOT
- XOR

### *Example of how to use logic operators*

For each operator, below you can find an example of how they work. In these examples only two inputs elements were considered.

**AND**

A	B	Y
0	0	0
0	1	0
1	0	0
1	1	1

**OR**

A	B	Y
0	0	0
0	1	1
1	0	1
1	1	1

**NOT**

A	Y
0	1
1	0

**XOR**

A	B	Y
0	0	0
0	1	1
1	0	1
1	1	0

## Settings

Settings are described below.

Parameter	Description
<b>Detectors</b>	Member loop and address
<b>Modules</b>	Member loop and address
<b>Zone</b>	Zone number
<b>ONERING</b>	Select the interested panel and the necessary device (detector, module, zone, ecc)
<b>Event</b>	Select the event type. Detector: <ul style="list-style-type: none"> <li>• Allarm</li> <li>• Fault</li> <li>• Disablements</li> </ul> Module: <ul style="list-style-type: none"> <li>• Allarm</li> <li>• Pre-Allarm</li> <li>• Fault</li> <li>• Disablements</li> <li>• Technological</li> </ul>
<b>Logic function</b>	Number of another logic function that activates this one.
<b>Delay</b>	Delay time, in seconds, between logic function activation and output activation.
<b>Length</b>	Output activation time, in seconds. If set to 0000, the outputs will remain active until the operator will reset them.
<b>Output Zone Associate</b>	Outputs activated by logic functions. These outputs must already be programmed (see <i>10.6 Output zones</i> ).

## Procedures

### To create a logic function:

1. Select the **Add** option: a list of available logic functions is displayed.
2. Select the first available logic function: the page where the logic function can be built appears.

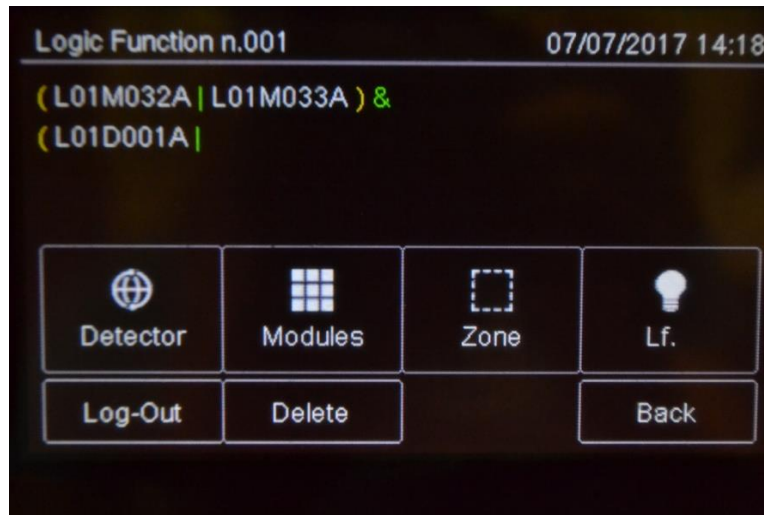

3. Press the input that will activate the logic function. The windows required to identify the device, event or logic function appear according to the selected input.
4. For devices only, select the input status that will activate the function.
5. Build the logic relations between the events.

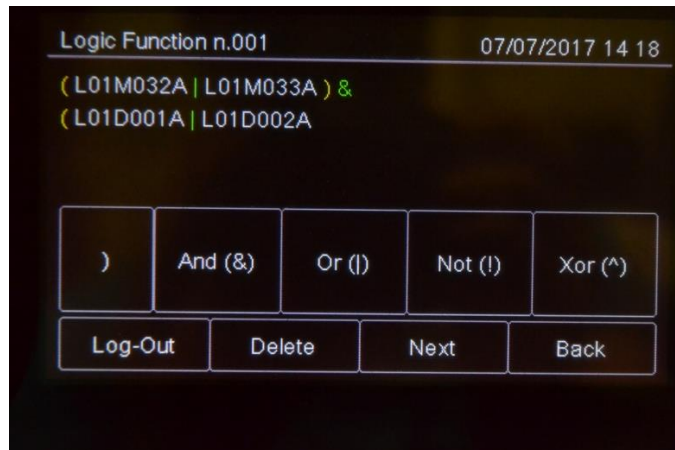

In the example, the logic function will be activated when sensor 001 in loop 1 triggers an alarm and detector 009 in loop 1 is in pre-alarm.

6. Press **Next** to move to the next window.

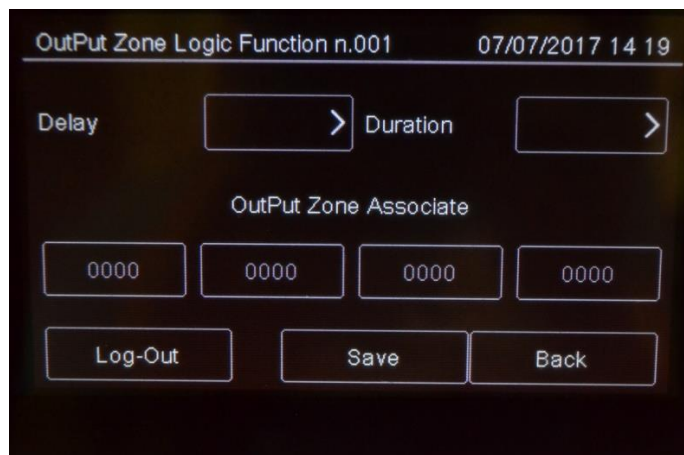

7. Set the required parameters.
8. Associate Output Zone

9. Press **Save** to confirm.

**To edit a logic function:**

1. Select the **Edit** option: a list of available logic functions is displayed.
2. Select the logic function to be edited.
3. Edit settings.
4. Press **Save** to confirm.

**To delete a logic function:**

1. Select the **Delete** option: a list of available logic functions is displayed.
2. Select the logic function to be deleted
3. Press **Save** to delete the logic function.



## 10.8 Setting system parameters



The following functions are reserved to the Programmer.

### 10.7.1 Setting the language



Programming menu -> Configure -> System -> General ->

Select the required language: the selected language is immediately applied.

The available languages (from version 1.0.A09) are:

- Italian
- English
- Turkish
- French
- Farsi
- Arabic
- Polish
- Estonian
- Romanian
- Portuguese
- Danish
- Slovenian
- Dutch
- Singapore
- Hebrew
- Chinese
- Lithuanian
- Spanish

### 10.7.2 Entering panel information



Programming menu -> Configure -> System -> General -> Panel info



The screenshot shows the 'Panel Info' configuration screen. At the top right, the date and time '07/07/2017 14 19' are displayed. The screen contains several fields and buttons:

- Panel Name:** A dropdown menu showing 'Teledata' with a right-pointing arrow.
- Support Center:** A dropdown menu showing 'Teledata Milano +39 0227201352' with a right-pointing arrow.
- Background:** Three buttons labeled 'Black', 'Blue', and 'Green'. The 'Black' button is currently selected and highlighted.
- Logo Costum:** Two buttons labeled 'Teledata' and 'Background'.
- Log-Out:** A button at the bottom left.
- Back:** A button at the bottom right.

### Settings

Settings are described below.

Parameter	Description
<b>Panel name</b>	Name assigned to the unit
<b>Support center</b>	Service center contact data
<b>Background</b>	Control panel background color (black, blue, green)
<b>Logo Custom</b>	Insert the password to personalize the panel with the customized logo.

### 10.7.3 Setting led and buzzer behavior

Programming menu -> Configure -> System -> General -> Buzzer-led



### Settings

Settings are described below.

Parameter	Description
<b>Buzzer</b>	Enables the panels buzzer. The buzzer sounds in the event of fault or alarm.
<b>Blinking led</b>	Activates the blinking led function on devices installed on the loop. The led blinks when queried by the panel.
<b>Red led</b>	Sets the device led blink color to red. The led blinks when queried by the panel.   Activate in systems with sensors without built-in insulator, like SFxxxxE series..

## 10.7.4 Setting remote communications



Programming menu -> Settings -> System -> General -> Supervision

This function lets you set parameters for communications with the unit via LAN or RS-232. This way the unit can be remotely monitored or programmed.

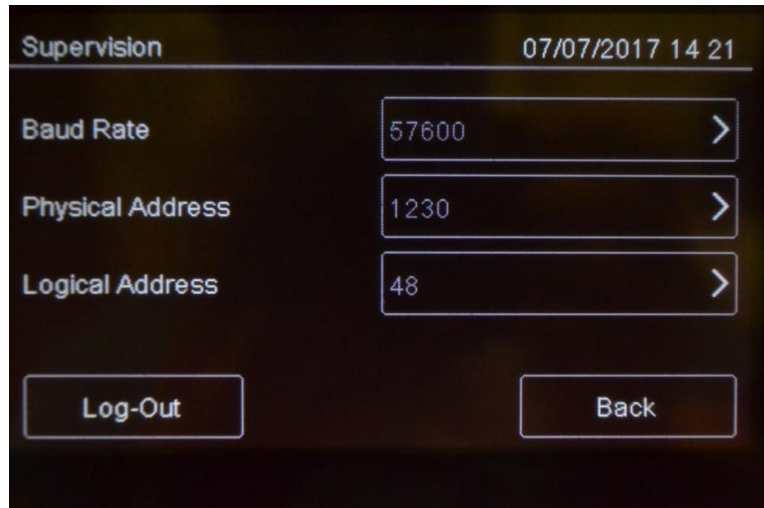

### Settings

Settings are described below.

Parameter	Description
<b>Baud Rate</b>	Select one of the available options (9600, 19200, 38400, 57600). Select the highest value for faster connections. If a PT-LAN network card is installed, set the same parameter for the network card.
<b>Physical address</b>	Physical supervisor address
<b>Logic address</b>	Logic supervisor address



Make sure the same values are set on the supervisor.

## 10.7.5 Setting loop features



Programming menu -> Configure -> System -> General -> Loop type

This function lets you specify for each loop in the system whether the loop is closed or open.

### Procedure

1. Set the type of each loop.
2. Press **Save** to confirm.

### 10.7.6 Restoring factory settings

Programming menu -> Configure -> System -> Values Factory



This function lets you restore factory settings.



Once this procedure is launched it cannot be interrupted, all setting changes will be deleted.

### 10.7.7 Setting peripheral features

Programming menu -> Configure -> System -> Peripherals



Here is possible to set peripherals on RS 485.

Remote Keypads ( maximum number 16)

Remote Mimic Panels ( maximum number 16)

### 10.7.8 Exporting data

Programming menu -> Configure -> System -> USB -> Export



This function will allow to export various data from the panel to a USB support.



The panel is compatible with USB supports with a capacity until 16Gb formatted in FAT32 with 4096 byte allocation table. It is necessary to format the device in such way with a PC.

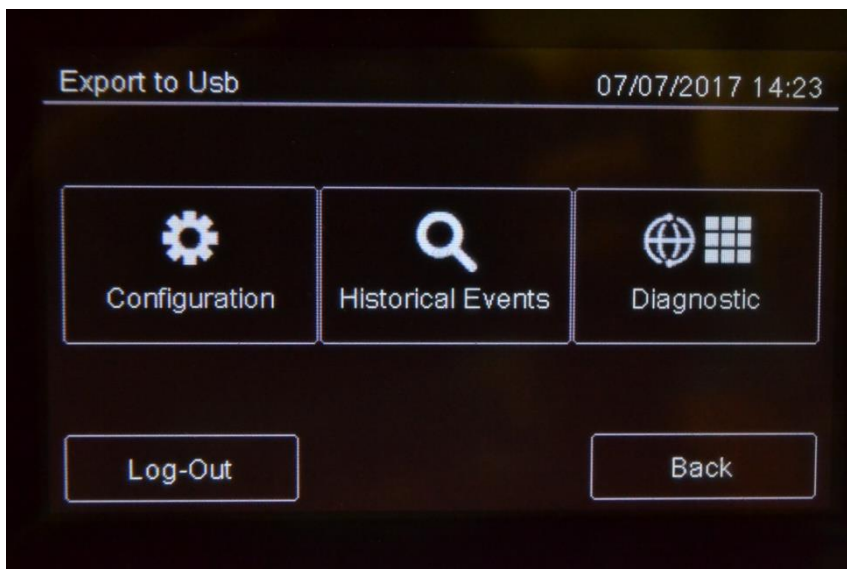

#### Procedure

- Insert a compatible USB support.

- Select “Configuration”, a file will be saved on the USB support in own format not modifiable, with name “ONELOOP.CFG”.

If a file called “ONELOOP.CFG” is already existing in the inserted USB support root, it will be overwritten, losing any previous past data exportation. Exporting time is around 3 seconds.

- Selecting “Events”, a .csv format file will be saved on the USB support, that can be opened with a software like Excel, called “EVNTLOG.CSV”.

If a file called “EVNTLOG.CSV” is already existing in the inserted USB support root, it will be overwritten, losing any previous past data exportation. Exporting time depends on the amount of events in memory. A panel with a full memory is around 60 seconds.

- Selecting “Diagnostics”, it is necessary to select also the desired loop.
- On the USB support a .csv format file will be created, that can be opened with a software like Excel, called “1DIAGLP.CSV”, where the number in front of the file is the selected loop of the panel.

If a file called “xDIAGLP.CSV” is already existing in the inserted USB support root, it will be overwritten, losing any previous past data exportation. Exporting time depends on the amount of devices connected to the desired loop. A loop with 240 devices connected, the exporting time is around 240 seconds.



To avoid data corruption, do not disconnect the USB support, do not stop the exporting procedure and do not turn off the panel.

### 10.7.9 Import data



**Programming menu -> Configure -> System -> USB -> Import**

This function will allow to import a previously saved configuration, file from a USB support to the panel.

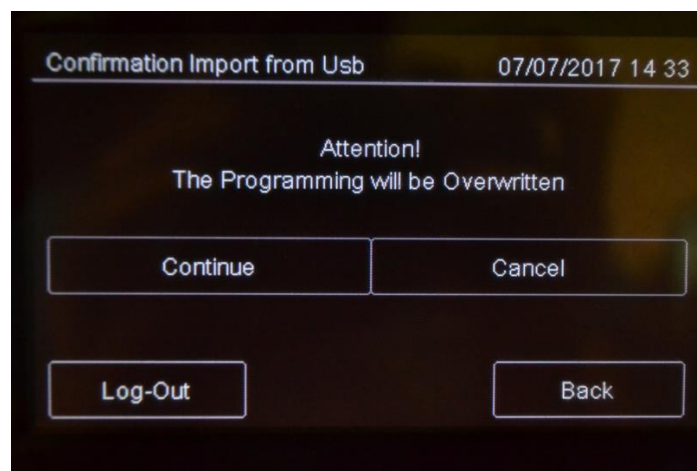

The panel is compatible with USB supports with a capacity until 16Gb formatted in FAT32 with 4096 byte allocation table. It is necessary to format the device in such way with a PC.

A configuration file called “ONELOOP.CFG” has to be existing in the inserted USB support root. The panel configuration will be overwritten with the one in the USB support. The

importing time is around 20 seconds. After the importing, the panel will restart with the new configuration.



To avoid data corruption, do not disconnect the USB support, do not stop the exporting procedure and do not turn off the panel.

### 10.7.10 Various system settings



Programming menu -> Configure -> System -> General -> Miscellaneous

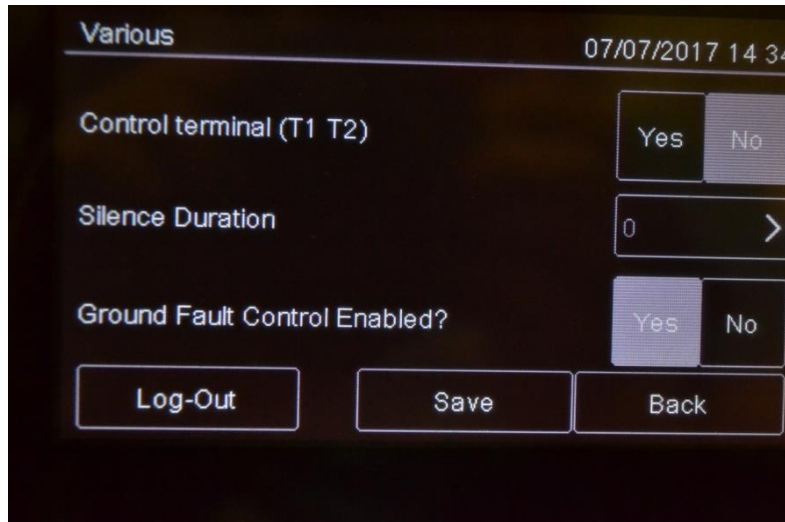

#### Settings

Settings are described below.

Parameter	Description
<b>T1&amp; T2 control</b>	This parameter set if panel can control T1&T2 procedure or not
<b>Silencing time</b>	Buzzer mute time in the event of persistent alarm. The buzzer restarts after this time if the alarm is not reset.
<b>Ground Fault Control</b>	<p>Runs the ground fault test to check for mains power ground dispersions and loop signal grounding.</p> <p> Activate this option to debug installation errors, especially short circuits between grounding and unit signals (such as, for example, a contact between cable shield and conductor).</p>

## 10.8 Setting the calendar.



The following functions are reserved to the Programmer.



### 10.8.1 Setting the date and time

Programming menu -> Configure -> Date & Time -> Date and Time

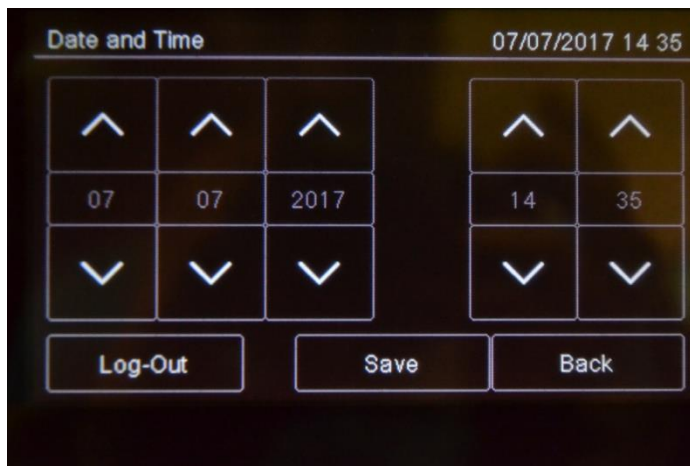

#### *Procedure*

1. Set the current date and time.
2. Press **Save** to confirm.

### 10.8.2 Setting daylight savings time

Programming menu -> Configure -> Date & Time -> Summertime



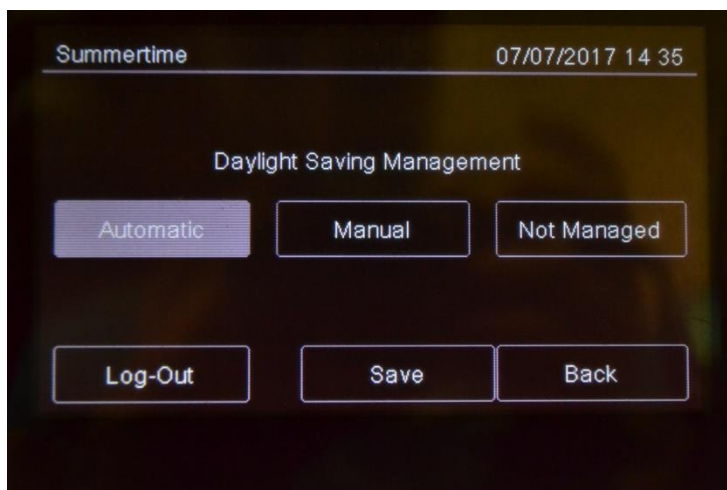

### Settings

Settings are described below.

Parameter	Description
<b>Automatic</b>	The panel automatically switches to daylight savings time.
<b>Manual</b>	Manually set the month and day daylight savings time starts and ends.
<b>Not managed</b>	Function not enabled, no daylight savings time period is calculated.



### 10.8.3 Setting holidays



Programming menu -> Configure -> Date & Time -> Holidays

This function lets you program holidays.

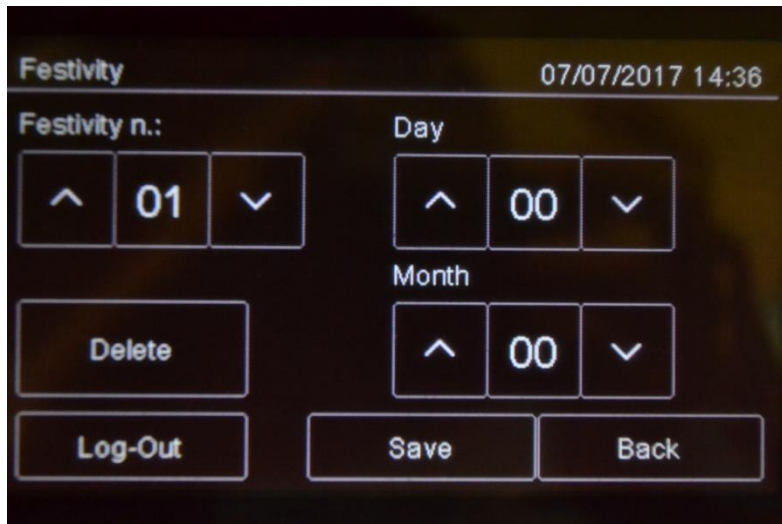

#### Settings

Settings are described below.

Parameter	Description
<b>Holiday no.</b>	Holiday ID (1-12)
<b>Day</b>	Holiday day
<b>Month</b>	Holiday month

### 10.8.4 Setting time intervals



Programming menu -> Configure -> Date & Time -> Time Slot ->

This function lets you set up to 255 daily time intervals.

#### Procedures

##### To create a new time interval:

1. Select the **Add** option: the list of time intervals is displayed.
2. Select a time interval not set.
3. Set the start date and time **[1]** and end date and time **[2]** for the time interval.
4. Press **Save** to confirm.

##### To edit an existent time interval:

1. Select the **Edit** option: the list of time intervals is displayed.
2. Select the time interval to be edited.
3. Change the start and end times.

4. Press **Save** to confirm.

**To delete an existent time interval:**

1. Select the **Delete** option: the list of time intervals is displayed.
2. Select the time interval to be deleted.
3. Press **Save** to confirm.

## 10.8.5 Setting weekly trends



**Programming menu -> Settings -> Date & Time -> Weekly trends**

This function lets you link previously created time intervals to days of the week.

*Procedures*

**To create a new weekly trend proceed as following:**

1. Select the **Add** option: the list of weekly trends is displayed.
2. Select a weekly trend not set.
3. Select the time interval to be linked for each day of the week. See *10.8.4 Setting time intervals* on how to create time intervals.
4. Press **Save** to confirm.

**To edit an existent weekly trend:**

1. Select the **Edit** option: the list of weekly trends is displayed.
2. Select the weekly trend to be edited.
3. Edit the time intervals linked to the days.
4. Press **Save** to confirm.

**To delete an existent weekly trend:**

1. Select the **Delete** option: the list of weekly trends is displayed.
2. Select the weekly trend to be deleted.
3. Press **Save** to confirm.

# 11. Use

## 11.1 Viewing events



The following functions are accessible to both the User and Programmer.



### Event Log Menu

The **Event Log** menu lets you view events logged by category. See 9.1.1 *Viewing events* for a description of the displayed information.

#### 11.1.1 Exporting data



### User menu -> Maintenance -> Export -> Events

This function will allow to export the event memory from the panel to a USB support.



The panel is compatible with USB supports with a capacity until 16Gb formatted in FAT32 with 4096 byte allocation table. It is necessary to format the device in such way with a PC.

### **Procedures**

- Insert a compatible USB support by using a MiniUSB to USB adaptor.
- Go to the declared menu

Selecting “Events”, a .csv format file will be saved on the USB support, that can be opened with a software like Excel, called “EVNTLOG.CSV”.

If a file called “EVNTLOG.CSV” is already existing in the inserted USB support root, it will be overwritten, losing any previous past data exportation. Exporting time depends on the amount of events in memory. A panel with a full memory is around 60 seconds.



To avoid data corruption, do not disconnect the USB support, do not stop the exporting procedure and do not turn off the panel.

## 11.2 Enabling users and changing login codes

Only the Programmer operator can enable or disable user operator login. Each operator can change their personal login code.

### 11.2.1 Programmer

Programming menu -> Configure -> Password

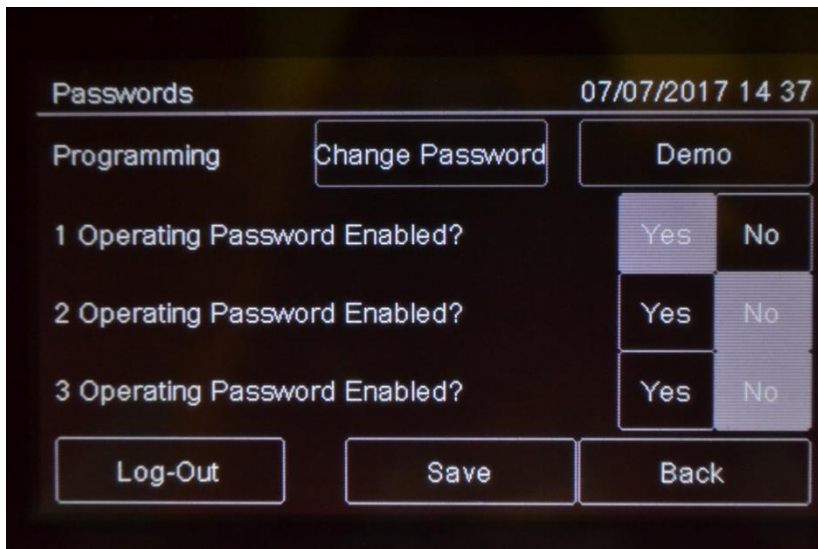

#### Procedures

##### To enable User login:

1. Set all Users who need to login to the unit to **Yes**.
2. Press **Save** to confirm.

##### To change the Programmer login code:

1. Select the **Change** option: the code change page is displayed.
2. Insert the new code.
3. Confirm the new code to save it.

## 11.3 Managing alarms

In case of alarm received from any device, the panel will activate immediately the internal siren output and will turn on the red LED on the front panel.

The device in alarm status will turn on its red LED.



To avoid a loop overload, in case of more than one alarm, a maximum of 10 red LEDs on the devices will be activated.



The following functions are reserved to the User

### 11.3.1 Mute alarms and the unit

User menu -> Silence 



Once this key is pressed, it is transformed into **Rearm**.

This function lets you temporarily mute system and panel alarms to check if a fire has actually broken out and reset them if necessary.

#### *Procedures*

##### **In the event of false alarm:**

Reset the panel (see 11.3.2 *Reset alarms and the unit*).

##### **In the event of real alarm:**

Press the **Siren Reset** key to turn sirens back on.

### 11.3.2 Reset alarms and the unit

User menu ->Reset 

This function resets triggered alarms and the unit.

If alarms or faults are not restored before the reset, after it will still be shown on the display from the central.



It's possible to perform a reset Hardware through the appropriate button on the master board.

### 11.3.3 Evacuation

User menu ->Evacuation 

This feature will put the panel into evacuation mode, activating all the outputs/sirens properly configured.

By activating the evacuation all the output modules programmed as "Activate evacuation" (see 10.4 *Modules*) will be activated, even if their zone is not active, and if the logic function where they are linked to is not yet valid.

## 11.4 Checking device status



The following functions are accessible to both the User and Programmer.

### 11.4.1 Check loop status



Maintenance -> Loop -> Status

#### *Procedure*

Select the required loop: loop type and status are displayed.

### 11.4.2 Resetting a loop



Maintenance -> Loop -> Reset

Select the required loop: this is automatically reset.

### 11.4.3 Run device diagnostics







Maintenance -> Diagnostics

This function lets you check connected device cleanliness.

#### *Sensor status*

Sensor status is indicated by the following colors:

Color	Device conditions
	Clean detector
	Medium clean detector
	Almost dirty detector
	Dirty detector

#### *Procedure*

1. Select the required loop: all connected devices are displayed.
2. Press a single sensor to view details.

## 11.4.4 Diagnostics export.

User Menu -> Maintenance-> Export -> Diagnostics



This function will allow to export the device diagnostics connected to the panel, to a USB support.



The panel is compatible with USB supports with a capacity until 16Gb formatted in FAT32 with 4096 byte allocation table. It is necessary to format the device in such way with a PC.

### Procedure

- Insert a compatible USB support.
- Go to the declared menu
- On the USB support a .csv format file will be created, that can be opened with a software like Excel, called “1DIAGLP.CSV”, where the number in front of the file is the selected loop of the panel.

If a file called “xDIAGLP.CSV” is already existing in the inserted USB support root, it will be overwritten, losing any previous past data exportation. Exporting time depends on the amount of devices connected to the desired loop. A loop with 240 devices connected, the exporting time is around 240 seconds.



To avoid data corruption, do not disconnect the USB support, do not stop the exporting procedure and do not turn off the panel.

## 11.5 Testing devices



The following functions are accessible to both the User and Programmer.

### 11.5.1 Running a Walk Test

Maintenance -> Test -> Sensors/Modules -> Walk Test



Walk test is used to check that the devices are able to generate an manually.





When devices are in this mode, the system does not generate any alarm and does not run the relevant procedures.

Different types of tests can be run:

- **Single:** used to test only one device.
- **Zone:** used to test devices in a specific zone.
- **Loop:** used to test devices in a the loop.

### Test results

The results are indicated by a color for all tests.

Color	Device conditions
	Test successfully completed.
	Device still not gone to alarm status.

### Procedures

#### To run a single test:

1. Press the **Single** option.
2. Select the device loop and address.

#### To run a zone test:

1. Press the **Zone** option.
2. Select the required zone.

#### To run a loop test:

1. Press the **Loop** option.



## 11.5.2 Testing the connection with modules and sensors



Maintenance -> Test -> Sensors/Modules -> Sensors/Modules

### Device connection

Connection status is indicated by a color for all devices.

Color	Device conditions
	Device correctly connected.
	Device connection error

### Procedures

#### To test the device connection:

1. Select the device address: the connection status with each loop device is displayed by a color. The below example illustrates a correct communication with loop 1 sensor 229.

## 11.5.3 Identifying conflicts



Maintenance -> Test -> Conflicts

This function lets you check whether two devices have the same address on the loop, in the system.

1. If several devices are displayed with the same address, change one.



## 11.5.4 Identifying mismatches



### Maintenance -> Test -> Mismatch

This function lets you check whether the device on the loop correspond really to the device typology configured in the panel (for example, whether a detector was programmed as a module or vice versa).

1. Start mismatch test
2. Correct any found mismatch.

## 11.5.5 Testing led operations



### Maintenance -> Test -> Led

This function lets you check whether all the LEDS on the panel and the RGB display values are correctly working.

## 11.6 Disable system elements



The following functions are accessible to both the User and Programmer.

### Maintenance -> Exclusions/Inclusions





Disabled devices do not send any alarm or fault signal. This compromises system safety. Only disable a device with strictly necessary and re-include it as soon as possible.

This function lets you bypass and re-include one or more unit devices. This feature will ignore any information received by the excluded device.

It is possible to disable:

- devices
- loop
- zones
- output zones
- additional boards (*Function not yet available*)

#### *Element conditions*

Symbol	Element condition
	Disabled element (detector in the example)
	Enabled element (detector in the example)

### 11.6.1 Disabling/Enabling a device



#### Maintenance -> Exclusions/Inclusions -> Devices

##### *Procedures*

#### To disable a detector:

1. Select the device to be bypassed.
2. Press **Save** to confirm. Sensor 001 is bypassed in the example.

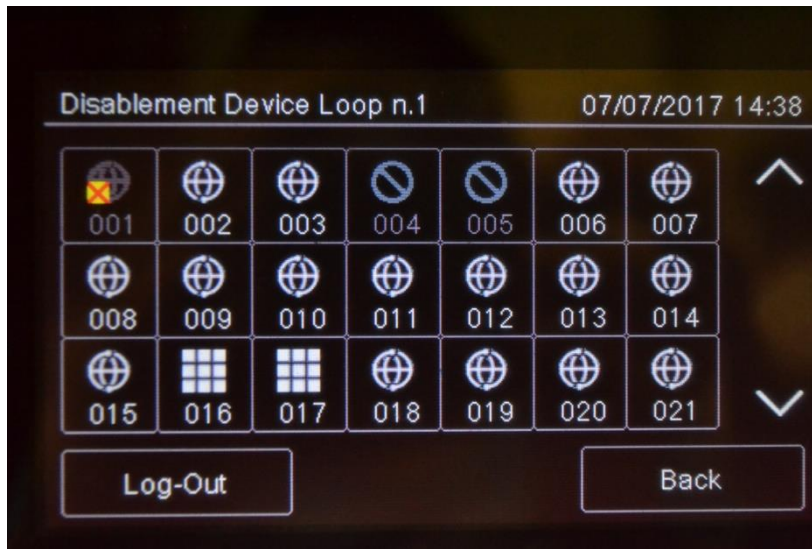

**To enable a previously bypassed detector:**

1. Select the bypassed device to be included.
2. Press **Save** to confirm.

**11.6.2 Disabling/Enabling a loop**



**Maintenance -> Exclusions/Inclusions -> Loop**



Warning: bypassing a loop automatically bypasses all devices connected to it.

*Procedures*

**To disable the loop:**

1. Press **Save** to confirm. Loop is bypassed.

**To enable a previously bypassed loop:**

1. Select the bypassed loop to be included.
2. Press **Save** to confirm.

**11.6.3 Disabling/Enabling a zone**



**Maintenance -> Exclusions/Inclusions -> Zone**



Warning: bypassing a zone automatically bypasses all connected loops and relevant devices.

*Procedures*

**To disable a zone:**

1. Select the zone to be bypassed:
2. Press **Save** to confirm.

### To enable a previously bypassed zone:

3. Select the bypassed zone to be included.
4. Press **Save** to confirm.

#### 11.6.4 Disabling/Enabling an output

Maintenance -> Exclusions/Inclusions -> Outputs



#### *Procedures*

##### To disable an output:

1. Select **Yes** for each output to be bypassed.
2. Press **Save** to confirm.
- 3.

##### To enable an output:

1. Select **No** for each output to be included.
2. Press **Save** to confirm.

#### 11.6.5 Disabling/Enabling a board

Maintenance -> Exclusions/Inclusions -> Additional boards



*Function currently unavailable.*

## 11.7 Modify a user password



The following functions are reserved to the User.



Maintenance -> Change password

This feature will permit to modify the password of the logged user.

##### To modify the User password:

1. Select the **Change** option: the code change page is displayed.

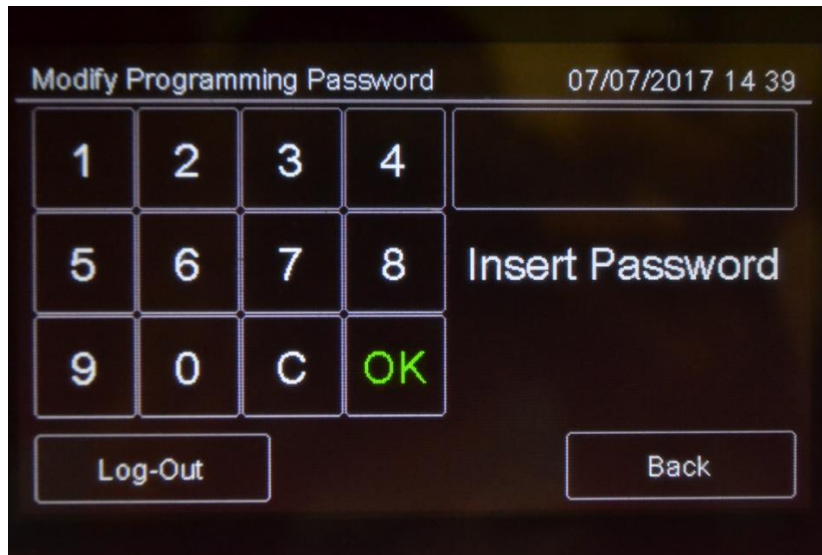

2. Insert the new code.
3. Confirm the new code to save it.

This new code must be used at the next login



Each user can modify their password. To activate other users (max 3) see paragraph 11.2.

### 11.7.1 Reminder



#### Maintenance -> Maint. Expiry

Here it's possible to program a message when maintenance time is expired.  
A pop up event will appear at midnight of date set.