



User and Installation Manual



Information ownership

© COPYRIGHT 2015, Teledata s.r.l.

All rights reserved.

Any full or partial distribution, modification or reproduction of this document are prohibited without written authorization by Teledata s.r.l. except the following actions:

- Fully or partially printing the document in its original format.
- Transferring the document on web sites or other electronic systems.
- Copying content without editing it and quoting Teledata s.r.l. as the owner of the copyright.

NOTE: the content of this document cannot thus, be used to develop other content for your retail purposes without a written authorization by Teledata s.r.l.

Requests for additional copies of this product or pertinent technical information should be addressed to:

Teledata s.r.l.

20132 Milan - Italy - Via G.M. Giulietti, 8

Tel.: +39 02 27 201 352 / +39 02 25 92 795

Fax: +39 02 25 93 704

E-mail: info@teledata-i.com

Declaration of conformity

This equipment was designed according to the quality, reliability and performance criteria adopted by Teledata.

Equipment must be professionally installed according to current regulations.

The equipment meets the following directives and standards:

EMC Directive (EMC) **2004/108/EC**

Low Voltage Directive (LVD) **2006/95/EC**

EN 54-2

EN 54-4 (A2:2006)

INDEX

1.	Introduction to this manual	7
1.1	Obligations to this manual	7
1.2	Manual data	7
1.3	Warnings for manual addressees	7
2.	Safeties and warranties	8
2.1	Safety rules	8
2.2	Intended use	8
2.3	Warranty restrictions	8
2.4	Technical support	8
3.	Product identification	9
3.1	Manufacturer's identification data	9
3.2	Packaging content	9
3.3	Identify the model and the serial number	9
3.4	Standards compliance	10
4.	Equipment management	11
4.1	Transportation	11
4.2	Environmental conditions	11
4.3	Unpacking	11
4.4	Replacement	11
4.5	Disposal	11
5.	Introduction to Teledata One	12
5.1	General features	12
5.2	Installation precautions	12
5.3	Technical specifications	13
5.3.1	HARDWARE features	13
5.3.2	Software features	13
5.4	Technical data	14
5.4.1	Datum plate	14
5.4.2	Electrical features	14
5.4.3	Functional features	14
5.4.4	Mechanical features	14
5.4.5	Environmental features	14

6.	Hardware Configuration	15
6.1	Control Panel Equipment	15
7.	Layout and connections	16
7.1	Logic board (TD571/E) layout	16
7.2	Logic board (TD574/E) layout	18
7.3	ONECONNECT Card (optional)	22
7.4	ONERING Card (optional)	24
7.5	Power supplies and batteries	28
7.6	System description	30
7.6.1	Relations between the elements of the plant	30
7.6.2	Sounder and load connection	30
7.7	Communication with detectors and modules	31
7.7.1	Open loop configuration	31
7.7.2	Generic loop connection requirements	32
7.7.3	Open loop configuration ("T" junctions)	32
7.7.4	Open loop connection with "T" junctions connection requirements	32
7.7.5	Closed loop configuration	33
7.7.6	Connection requirements for a closed loop connection	33
7.7.7	Connectable loop devices	33
7.8	Connection to host computer	37
7.8.1	Point2Point connection	37
7.8.2	LAN or WAN connection	38
7.8.3	Teledata One control panel ring network	39
7.9	Power supply	40
7.9.1	Network input features	40
7.9.2	Grounding features	40
7.9.3	Panel power supply features	40
7.10	Panel internal cabling	41
8.	Control panel	43
8.1	Status led	43
8.2	Graphic interface	44
8.3	Types of users	44
8.4	Access levels	45
9.	Basic operations for any operator	46
9.1	View basic information	46
9.1.1	Viewing events	47
9.1.2	Viewing assistance information	48

9.2	Login	49
<hr/>		
10.	Configuration	51
<hr/>		
10.1	Setting up the panel	51
10.1.1	Setting up expansion boards	51
10.1.2	Onering	52
10.1.3	Selection of the loop protocol	52
10.1.4	Run auto-addressing	52
10.1.5	Run self-programming	53
10.2	All In All Out configuration	54
10.3	Detectors configuration	55
10.4	Modules configuration	57
10.5	Zones configuration	61
10.5.1	Link an event to a zoneSettings	61
10.5.2	Linking loops to zones	62
10.5.3	Linking devices to zones	62
10.5.4	Set zone operating parameters	63
10.5.5	Link an output module to a zone	64
10.6	Output zones configuration	65
10.7	Logic functions configuration	66
10.8	Setting system parameters	70
10.8.1	Setting the language	70
10.8.2	Entering panel information	70
10.8.3	Setting led and buzzer behavior	71
10.8.4	Setting remote communications	72
10.8.5	Setting loop features	73
10.8.6	Restoring factory settings	73
10.8.7	Setting peripheral features	73
10.8.8	Exporting data	73
10.8.9	Importing data	75
10.8.10	Various system settings	76
10.9	Setting the calendar.	77
10.9.1	Setting the date and time	77
10.9.2	Setting daylight savings time	78
10.9.3	Setting holidays	79
10.9.4	Setting time intervals	79
10.9.5	Setting weekly trends	80
<hr/>		
11.	Use	81
<hr/>		
11.1	Viewing events	81
11.1.1	Exporting data	81
11.2	Enabling users and changing login codes	82

11.2.1	Programmer	82
11.3	Managing alarms	82
11.3.1	Mute alarms and the unit	83
11.3.2	Reset alarms and the unit	83
11.3.3	Evacuation	83
11.4	Checking device status	84
11.4.1	Check loop status	84
11.4.2	Resetting a loop	84
11.4.3	Run device diagnostics	84
11.4.4	Diagnostics export.	85
11.5	Testing devices	85
11.5.1	Running a Walk Test	85
11.5.2	Testing the connection with modules and sensors	86
11.5.3	Identifying conflicts	86
11.5.4	Identifying mismatches	87
11.5.5	Testing led operations	87
11.6	Disable system elements	88
11.6.1	Disabling/Enabling a device	88
11.6.2	Disabling/Enabling a loop	89
11.6.3	Disabling/Enabling a zone	90
11.6.4	Disabling/Enabling an output	90
11.6.5	Disabling/Enabling Protected	90
11.7	Modify a user password (second level only)	91
11.7.1	Reminder	91

1.Introduction to this manual

1.1 Obligations to this manual



Warning: this manual is an integral part of the equipment and must be kept for its entire working life. The manual must be enclosed with the equipment in the event of transfer to third parties.

The manual must be consulted for all those situations tied to the equipment's working life from its receipt until its disposal.

It must be kept in a clean place accessible to operators, and kept in good conditions.

1.2 Manual data

Equipment:	Teledata One
Title:	User and Installation Manual
Code or edition:	v. 1.3.9 ENG
Print month and year:	December 2020
Manual type:	original instructions

1.3 Warnings for manual addressees

Graphic concepts adopted in the text are illustrated below.



Warning: operations to be carefully performed or important information.



Note: important information, highlighted after the text they refer to.



Suggestions: practical information for good function operations.

2. Safeties and warranties

2.1 Safety rules

The information in this manual section aim to ensure that the device is correctly installed and handled. It is assumed that anyone who has to do with the device is familiar with the content of this chapter.

2.2 Intended use

The equipment must only be installed and used as described in this manual and for the purposes described in the advertising material distributed by Teledata S.r.l. It can only be connected to equipment, components and devices manufactured by third parties as recommended and permitted in this manual or by Teledata S.r.l. directly.

The equipment was designed, manufactured and tested to meet the stated safety standards. If, during the design of the systems in which it is installed, installation and use the instructions in this manual are followed, the equipment is not harmful to people or property.

2.3 Warranty restrictions

Teledata is not liable for direct or indirect damages to people or property due to equipment use in conditions other than those intended.

Qualified personnel must install this equipment strictly following the instructions in this manual and according to local laws, standards and safety regulations in effect.

This product is guaranteed against material and factory defects for **12 months from inspection date**. The warranty does not cover defects due to:

- Improper use and neglect.
- Damages due to exposure to the elements.
- Vandalism.
- Material wear.

The warranty is invalid when faults are due to improper use or operating procedures not contemplated in this user manual.

2.4 Technical support

This manual was drafted with care and is intended for qualified personnel. For any questions or special technical requests, please contact our personnel. Please write or call to contact personnel able to answer your questions and provide assistance.

Service email: info@teledata-i.com

Service phone number: +39 0227201352

Service fax number: +39 022593704

3. Product identification

3.1 Manufacturer's identification data

Teledata s.r.l.

Head office 20132 Milan - Italy - Via G.M. Giulietti, 8

Operating center 20063 Cernusco Sul Naviglio - Italy - Via Brescia, 24

Tel.: +39 02 27 201 352 / +39 02 25 92 795

Fax: +39 02 25 93 704

E-mail: info@teledata-i.com

3.2 Packaging content

The packaging contains the following items:

Description	Quantity
Teledata One panel	1
Cable kit	1
Resistances, diodes and jumpers kit	1
Installation and user manual (this manual)	1

3.3 Identify the model and the serial number

Inside the control panel there is an identification sticker that must not be removed under any circumstance. Please see plate information for service calls, maintenance or accessories.



3.4 Standards compliance

- **EN 54-2:** Fire detection and fire alarm systems - Control and indicating equipment.
- **EN 54-4:** Fire detection and fire alarm systems - Power supply equipment (integrated in the control panel).
- **Product type:** Fire detection and fire alarm systems for buildings.
- **Intended use:** Fire safety.

Essential characteristic	Harmonized tech. spec.	
	EN54/2:1997/A1:2006/AC1999	EN54/4:1997/A2:2006/AC:1999
Performance under fire condition	cl. 4, 5, 7	-
Response delay (response time to fire)	cl. 7.1, 7.7	-
Operational reliability	cl. 4, 5, 6, 7, 8, 9, 10, 12, 13, 14	cl. 4, 5, 6, 7, 8
Durability of reliability: Temperature resistance	cl. 15.4	cl. 9.5
Durability of reliability: Vibration resistance	cl. 15.6, 15.7, 15.15	cl. 9.7, 9.8, 9.15
Durability of reliability: Electrical stability	cl. 15.8, 15.13	cl. 9.9
Durability of reliability: Humidity resistance	cl. 15.5, 15.14	cl. 9.6, 9.14

4. Equipment management

4.1 Transportation

Once the equipment is carefully packaged and boxed, typical precautions must be taken during transport meaning the box must be positioned and secured to avoid tipping or falling that could damage equipment. Temperature limits must also be observed.

4.2 Environmental conditions

Observe temperature limits:

-40° / +70°C for storage and transport.

-5° / +40°C for operations.

4.3 Unpacking

Upon receiving the equipment, carefully unpack, being careful to dispose waste according to current waste disposal regulations.

4.4 Replacement

To replace obsolete equipment, disconnect it and connect the new device according to the relevant installation diagrams.

Dispose of the old equipment according to current waste disposal regulations.

4.5 Disposal

Avoid destruction by incineration and disposal in waterways. The product must be safely disposed.

Before disposal, batteries must be removed from all products containing batteries being careful to avoid short circuits. Observe current regulations for battery disposal.

5. Introduction to Teledata One

5.1 General features

Teledata One is a microprocessor-programmable fire detection control panel. This control panel uses an analogue addressed system and an autonomous management of indications and warning procedures.

The control panel is able to manage the fire detection through 1 analogue addressed lines, expandable up to 9.

Every loop can control up to 240 detectors and IN/OUT modules (ONEprotocol/Argus), 126 devices

(Apollo XP95/Discovery), 240 devices (Apollo Soteria).

The system is provided with a 32-bit microprocessor with RAM, flash memory and EEPROM memory for the non-volatile storage of the configuration data.

The control panel can be programmed using the touch screen or by importing programming data from a USB key.

Like all Teledata products, Teledata One can be managed through the integrated supervisory and control software.

5.2 Installation precautions

The electronic boards are provided with semiconductors that are sensitive to electrostatic charges. For this reason the boards should be handled by their edges and their electronic components should not be touched.

Carry out a good grounding in order to reduce the damageability and noise sensibility.

During the phase of designing the system, required autonomy should be taken into consideration in order to scale the batteries to be utilized.

Disconnect the batteries, the AC power and any power supply before inserting or removing an electronic board and before carrying out any maintenance work on the control panel (except for the loading of a new FW version).

Peripheral devices like detectors, modules, sounders etc. that are not compatible with the control panel can cause an improper operation of the control panel or even damage it.

It is therefore necessary to use materials compatible with the Teledata control panels.

Teledata One control panel must be used with n°2 12V - 7.2Ah or 17Ah batteries

5.3 Technical specifications

5.3.1 HARDWARE features

- 32 bit microprocessor addressable control panel.
- 1 loop addressable with digital protocol, configurable as open or closed.
- Expandable up to 9 loops.
- Graphic touch screen display (480x272 TFT 4.3”).
- Loop short circuit protection.
- 14 front LEDs.
- 1 supervised output for siren or dialer (24Vdc @ 500mA).
- 1 general form C output (30Vdc/120 Vac @ 1A).
- 1 general open collector output.
- 1 RS-485 line for peripherals.
- 1 RS-232/microUSB for programming.
- Colored side led.
- 56 zone leds. (OPTIONAL board).
- Battery capacity: 2x7.2Ah or 2x17Ah with EN54-4 charger management.
- Supervised AUX power supply output 24 Vdc @ 500mA with shortcut protection.
- Dimensions: 410x410x120 mm
- Power Supply: 230V AC

5.3.2 Software features

- Up to 240 addressable device for loop (OneProtocol)
- Up to 240 addressable device for loop (Argus)
- Up to 126 addressable device for loop (Apollo XP95/ Discovery)
- Up to 240 addressable device for loop (Apollo Soteria)
- Splitting up to 192 detection zone.
- 192 logical functions.
- Archival more than 850 events.
- Analog loops auto programming.
- Analog loops auto addressing (Argus only)
- Connection with other control panels using a fault tolerant network.
- Multiple language management.
- Fully customizable with personal logo, color and multicolored side LEDs.
- Management of different types of analog detectors and modules:
 - Thermal, optical and mixed detectors
 - Input Modules
 - Output Modules
 - Addressed call points
 - Addressable sirens
 - Wireless translator

5.4 Technical data

5.4.1 Datum plate

Primary voltage	230 Vac / 50 Hz
Primary consumption	300mA ~
230V~ fuse	F4Ah

5.4.2 Electrical features

Minimum operating voltage	21.6 V
Backup batteries	n° 2 (12Vdc/17Ah or 12Vdc/7.2Ah)
Maximum internal batt resistance	800mOhm
Available current for external loads	500mA
Standby absorption	300 mA – 27V
Monitored sounder line	Max. 500mA – 27.6V DC
Fault relay	Max. 1A - 30V DC/120V AC
I max. a	1450 mA
I max. b	1450 mA
I min.	300 mA

5.4.3 Functional features

Operating keyboard	Touch screen
Optical messages	Led
Acoustic messages	Buzzer
Visualization of the events	480x272 TFT 4.3"
Serial output for PC	N° 1 – RS232
Event log	Max. 850
Working mode	Guarded/Unguarded
Programming/Management hardware key	Multilevel password
Number of analogue lines	1 loop exp. To 9 loops
Exclusion of the analogue line	Single – multiple
I/O Modules / Detectors for each line	Max. 240
Programming type	Manual or by PC
Configuration of the analogue line	192 software zones
Analogue lines connection	Open or closed loop
Length of the detector lines	Max. 5000m
Type of cable	Shielded

5.4.4 Mechanical features

Protection level	IP30
Cabinet	Iron
Dimensions (WxLxD)	410 x 410 x 120 mm
Weight (without batteries)	6 Kg
Painting	Epoxy resin
Color	Black, white
Conduit holes	4 x 25 mm

5.4.5 Environmental features

Storage temperature	(-40 ÷ +70)°C
Operating temperature	(-5 ÷ +40)°C
Operating humidity (relative)	90%

6. Hardware Configuration

6.1 Control Panel Equipment

When fully equipped the control panel can include:

- 1 main logic board (TD571/E)
- 4 loop expansion logic boards (ONE2)
- 1 synoptic led (ONE56)
- 1 ONECONNECT network card (for LAN or WAN network connection)
- 1 ONERING card (for panel network connection)
- 2 batteries (max 12V @ 18Ah)
- 1 additional power supply (ONEPW)

7. Layout and connections

7.1 Logic board (TD571/E) layout

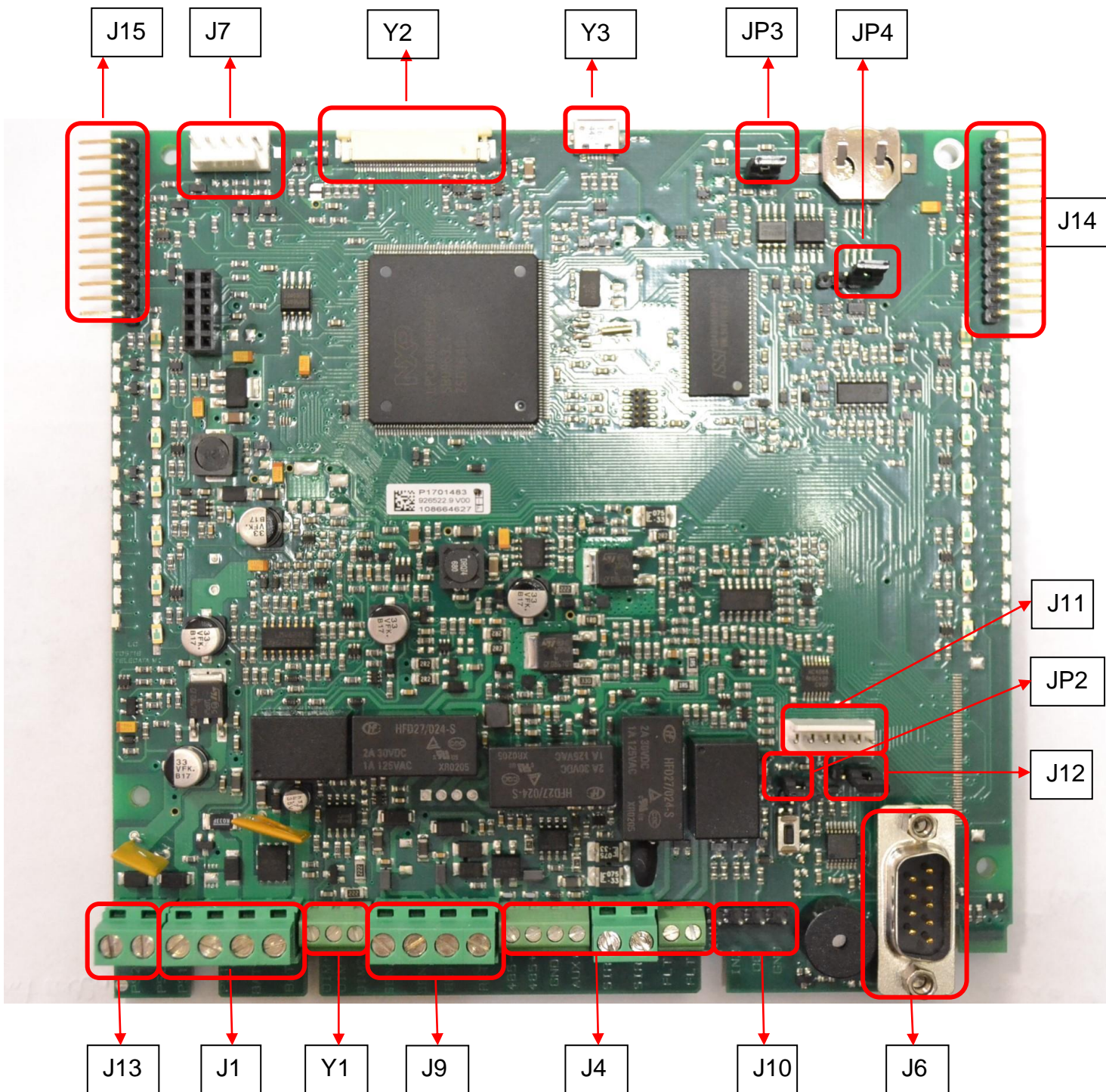

The following connectors are available:

- **Connectors J15 & J14:** connection of ONE2 loop expansion boards
- **Connector J7:** ONERING card connections
- **Connector Y2:** touch screen connection
- **Connector J11:** ONECONNECT card connections
- **Connector J13:** AL2 power supply
- **Connector J1:** AL1 power supply and batteries
- **Connector Y1:** DIM power supply control
- **Connector J9:** fire loop send and return
- **Connector J4:** RS-485, AUX output, monitor output, type C fault output
- **Connector J10:** for logical in/out
- **Connector J6:** for RS-232 connection.
- **Connector JP3:** for programming protection (closed=enabled)
- **Connector JP4:** to set watchdog state.
- **Connector JP2:** to set Update FW state. (closed = update FW)
- **Connector J12:** to select the serial (to the right=RS232-to the left=LAN)
- **Connector Y3:** connector USB port: If it is used a TD571E, the connector is a micro USB port; if it is used a board old than TD571E, the connector is a mini USB port



J13, J1, Y1, J14 and J15 are connectors with predefined wiring and should be connected to elements that are already installed in the control panel. These connectors should be disconnected and reconnected only in case boards have to be replaced or added.

The respective wiring of the connectors J9, J4, J10, J6, J11 and J7 depends on the equipment configuration in which the control panel is connected.

Further on are described the connector functionalities.

Connector J13

PIN no.	NAME	FUNCTIONALITY
1	PS2+	PS2 positive power supply
2	PS2-	PS2 negative power supply

Connector J1

PIN no.	NAME	FUNCTIONALITY
1	PS1+	PS1 positive power supply
2	PS1-	PS1 negative power supply
3	BAT -	Batteries -
4	BAT +	Batteries +

Connector Y1

PIN no.	NAME	FUNCTIONALITY
1	DIM+	DIM+ control PS1 power supply
2	DIM-	DIM- control PS1 power supply
3	DIM2	DIM control PS2 power supply

Connector J9

PIN no.	NAME	FUNCTIONALITY
1	FW+	Loop Send +
2	FW-	Loop Send -
3	RET+	Loop Return +
4	RET-	Loop Return -

Connector J4

PIN no.	NAME	FUNCTIONALITY
1	485-	RS-485 line -
2	485+	RS-485 line +
3	GND	Ground
4	PSOUT	AUX power output (27Vdc @ 500mA)
5	SIR+	Supervised output +
6	SIR-	Supervised output -
7	AL	Fault output NC
8	AL	Fault output NC

Connector J10

PIN no.	NAME	FUNCTIONALITY
1	IN1	Digital input 1
2	IN2	Digital input 2
3	OC	Open collector
4	GND	Ground

7.2 Logic board (TD574/E) layout

The ONE2 expansion card permits to add additional 2 addressable loops to the panel. In the maximum configuration, up to 4 ONE2 cards can be added, giving up to 9 addressable loops.

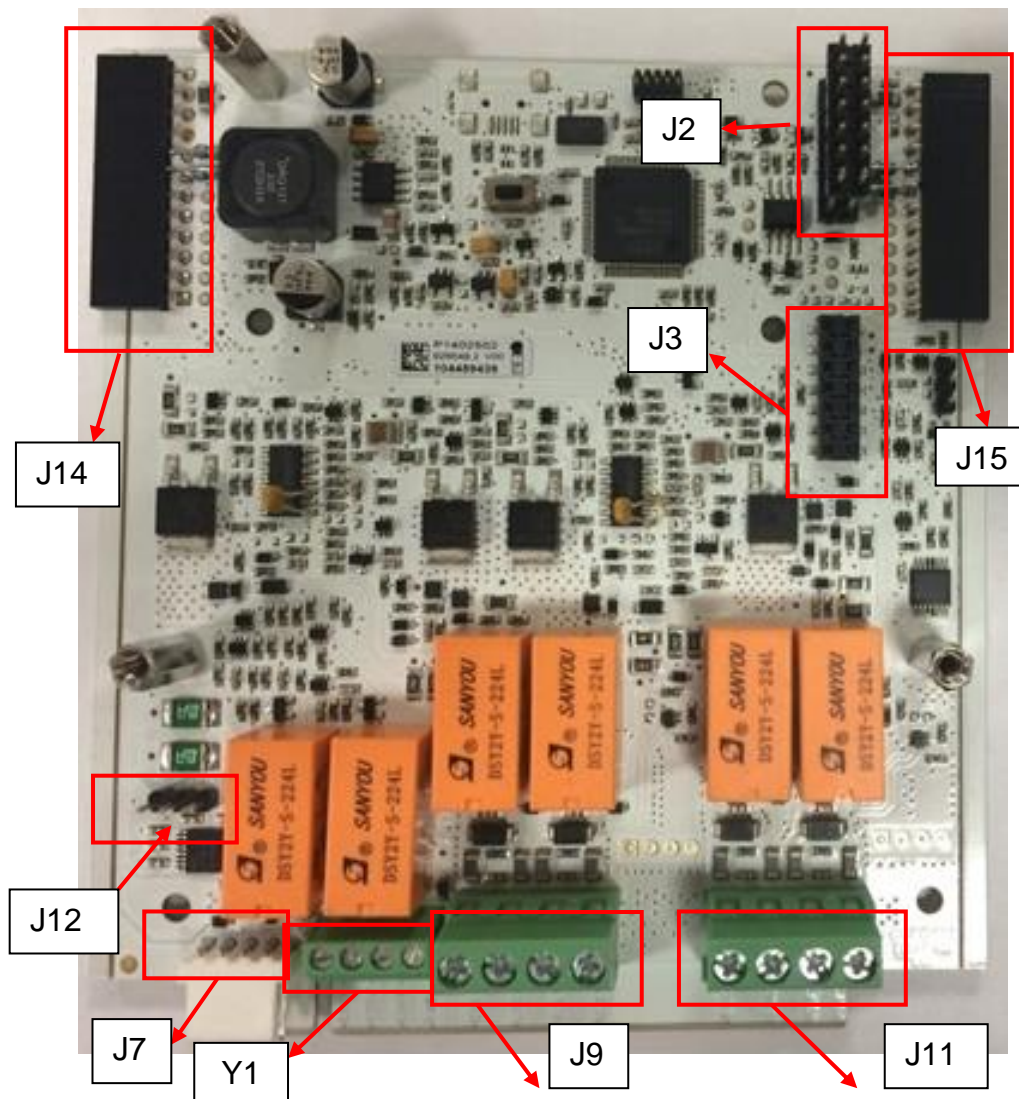

The following connectors are available:

- **Connectors J15 & J14:** connection to main board
- **Connectors J2 and J3:** EXP connections
- **Connector J7:** serial port for FW upgrade
- **Connector Y1:** Not managed
- **Connector J9:** connection to loop 1
- **Connector J11:** connection to loop 2
- **Connector J12:** serial setting

Further on are described the connector functionalities.

Connector J9

PIN no.	name	FUNCTIONALITY
1	SEND1+	Loop 1 Send +
2	SEND1-	Loop 1 Send -
3	RET1+	Loop 1 Return +
4	RET1-	Loop 1 Return -

Connector J11

PIN no.	name	FUNCTIONALITY
1	SEND2+	Loop 2 Send +
2	SEND2-	Loop 2 Send -
3	RET2+	Loop 2 Return +
4	RET2-	Loop 2 Return -

Install the expansion cards as shown in follow images:

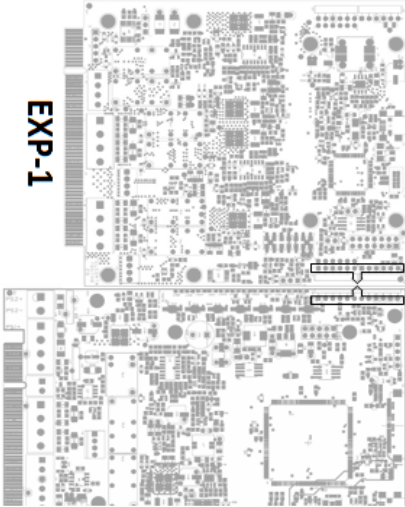
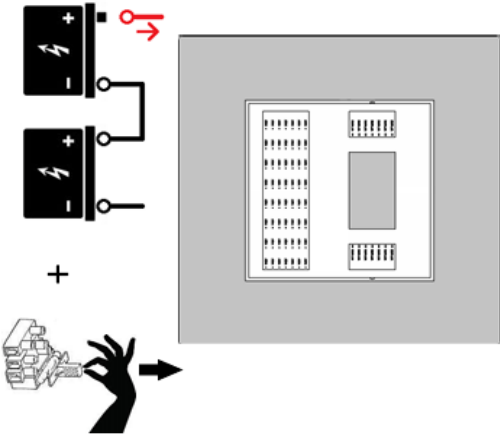
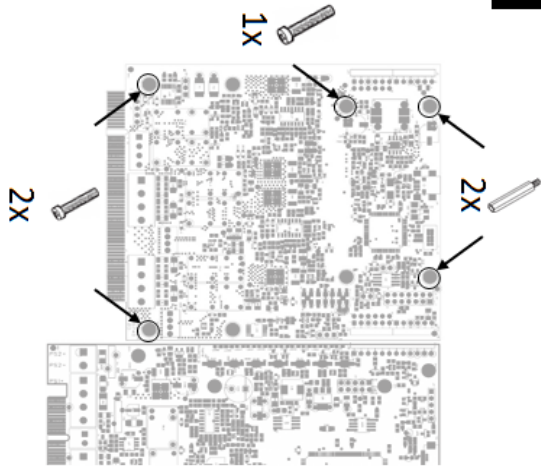
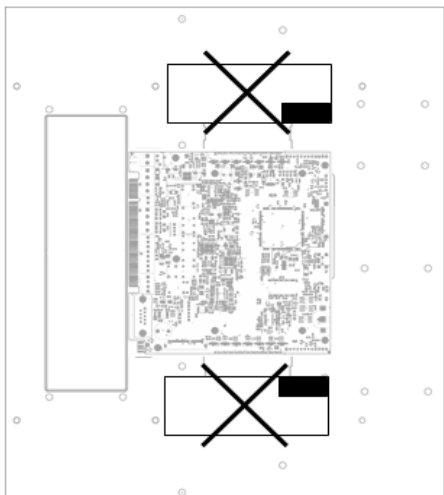
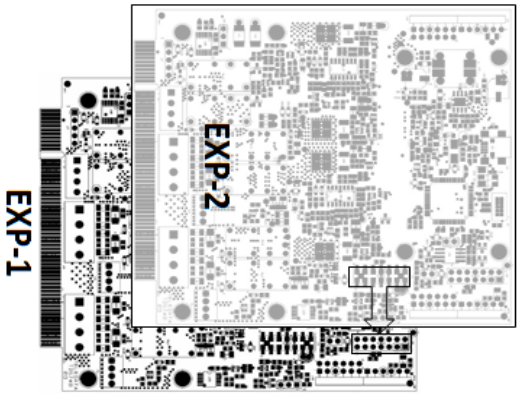
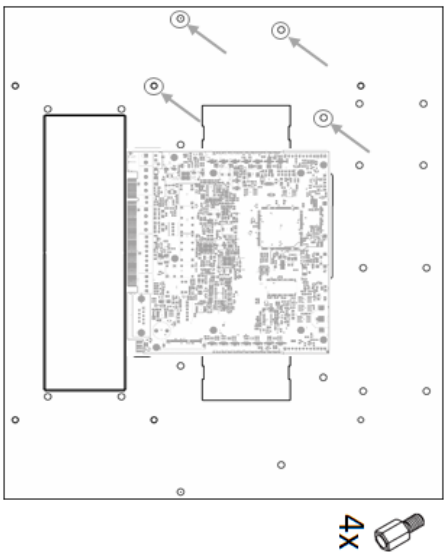
<p style="text-align: right;">4</p> 	<p style="text-align: right;">1</p> 
<p style="text-align: right;">5</p> 	<p style="text-align: right;">2</p> 
<p style="text-align: right;">6</p> 	<p style="text-align: right;">3</p> 

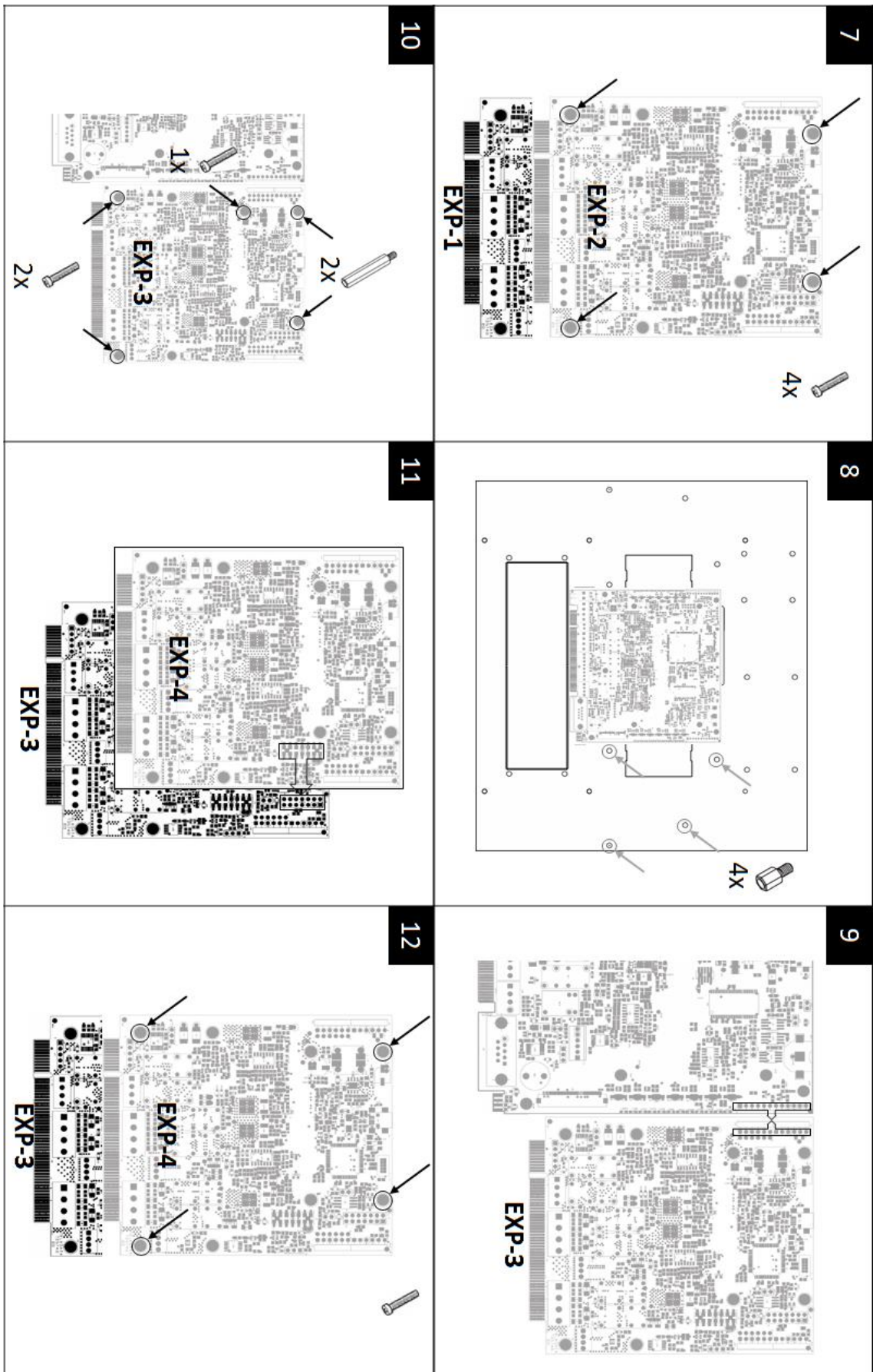

Each card is automatically addressed depending on the installation position, so it is strictly necessary to follow the card order, as below described:

1. Turn off the panel, disconnecting the batteries and removing the fuse.
2. Remove the side protections (only left side if up to two ONE2 cards are installed).
3. Insert 4 5mm M/F standoffs.
4. Insert J15 connector of the first expansion card (EXP1) in J15 connector of the motherboard (TD571/E).
5. Fix EXP1 card with three 3x6mm screws and one 15mm M/F standoff.
6. Assemble EXP2 expansion card on top of EXP1 card, by inserting EXP2 J3 connector into EXP1 J2 connector.
7. Fix EXP2 card with four 3x6mm screws.
8. If more than two expansion cards are necessary, insert four 5mm M/F standoffs.
9. Insert J14 connector of the third expansion card (EXP3) in J14 connector of the motherboard (TD571/E).
10. Fix EXP3 card with two 3x6mm screws and two 15mm M/F standoffs.
11. Assemble EXP4 expansion card on top of EXP3 card, by inserting EXP4 J3 connector into EXP3 J2 connector.
12. Fix EXP4 card with four 3x6mm screws.

7.3 ONECONNECT Card (optional)

The ONECONNECT card, if included, is supplied with a flat cable and must be connected to the main board on connection J11 as shown below:

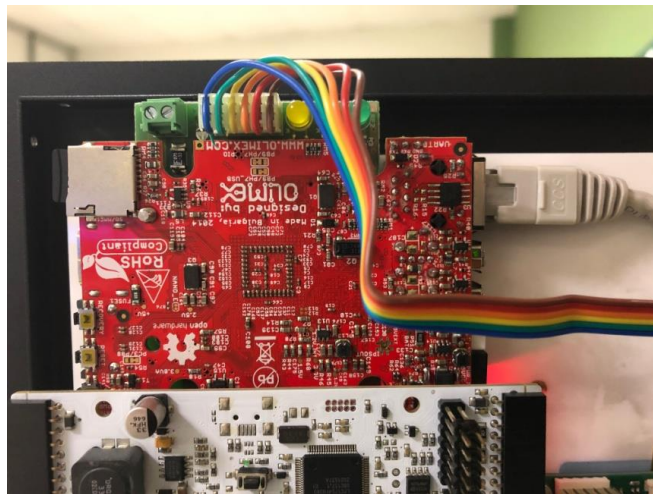

Connect as shown:

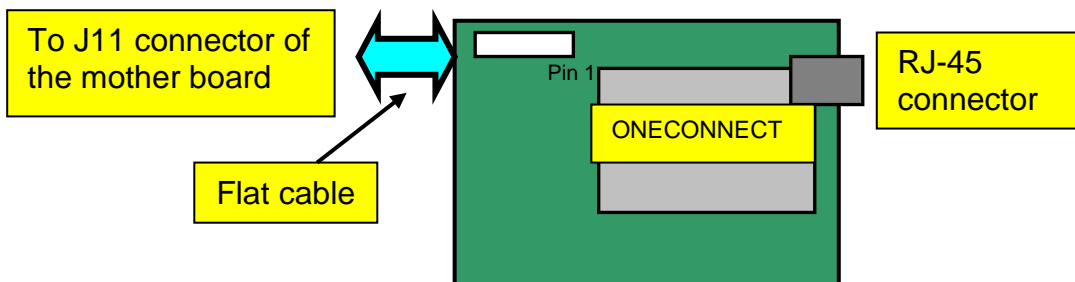

- Connect the flat cable to the connector of the network card and to connector J11 of the main board.



To avoid damaging, do not force connector insertion.

Connect the control panel to the network card on connector RJ-45 of the network card using:

- **10BASE-T crossed** network cable: for connection to the host PC
- **10BASE-T direct** network cable: for connection to a hub.

7.4 ONERING Card (optional)

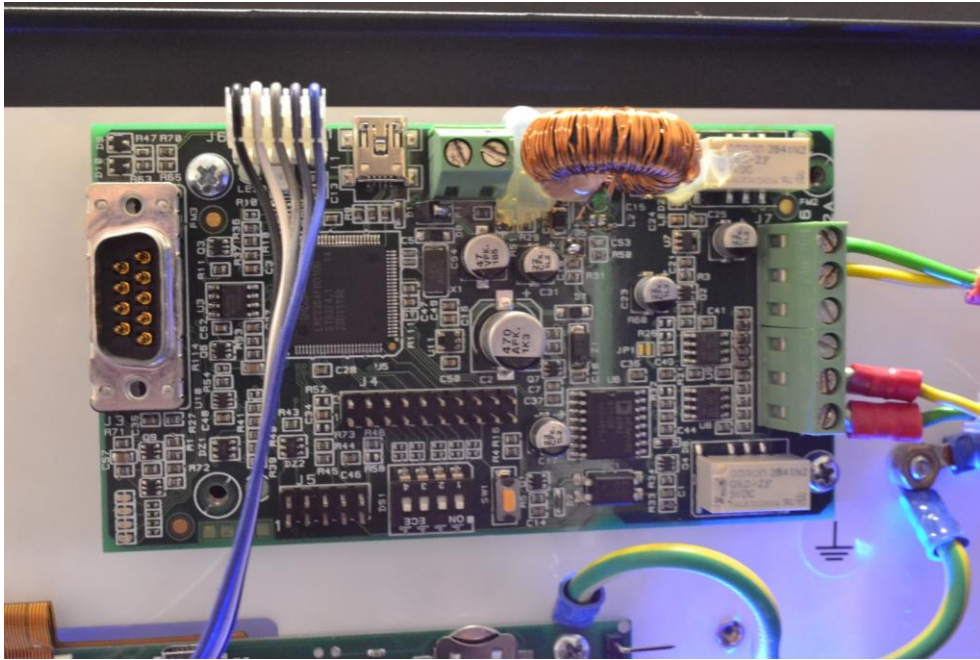

The ONERING expansion card permits to connect up to 32 TeledataONE and Olympia model panels. The purpose is to share information between panels, allowing also to do cross outputs activations.

The ONERING card, is supplied with a flat cable and must be connected to the main board on connection J7 as shown below:

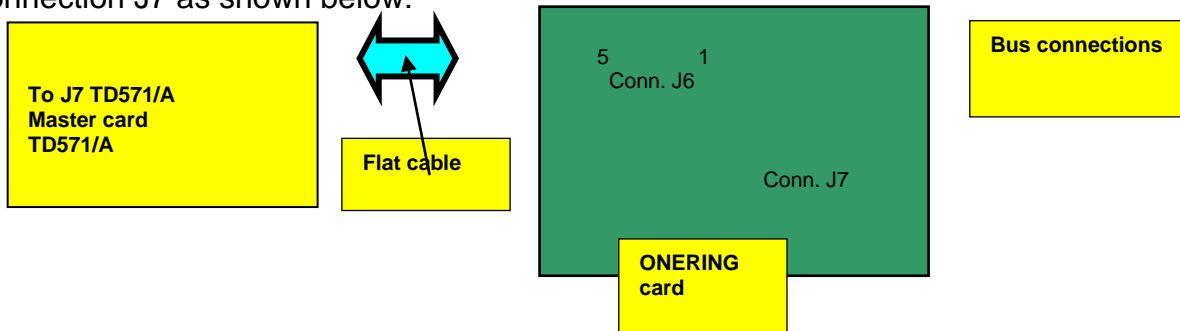

The control panel should be connected with cables with the following technical specifications:

- Use CAN bus cable with granted impedance 120Ω. (es. Belden 9842)
- Max distance at 50 kbit/s : 1000m

Network cable characteristics

LENGTH	TYPE OF CABLE
Up to 40mt	0.25-0.34mm ²
Up to 300mt	0.34-0.6mm ²
Up to 600mt	0.5-0.6mm ²
Up to 1000mt	0.75-0.8mm ²



With shielded and twisted 1mm² fire cable, maximum distance at 50Kbit/s speed is 400m.

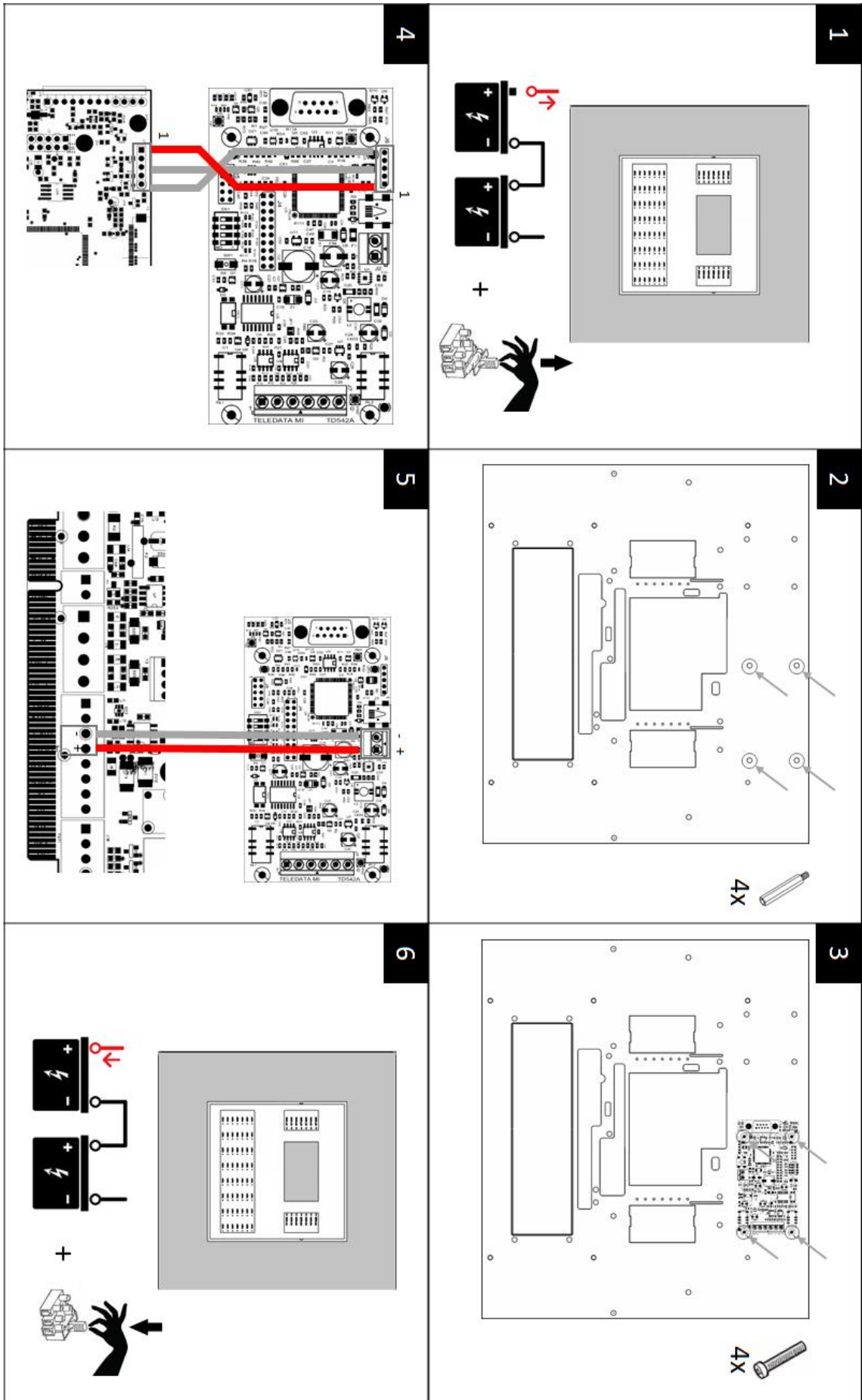

ONERING expansion card installation is described below:

1. Turn off the panel, disconnecting the battery and removing the fuse.
2. Insert four 5mm M/F standoffs.
3. Assemble the ONERING card and fix it with four 3x6mm screws.
4. Connect the data flat cable in J7 connector of TeledataONE panel.
5. Connect the power cable to PSOUT+ and GND terminals of J4 connector of TeledataONE panel.
6. Turn on the panel, connecting the battery and inserting the fuse.

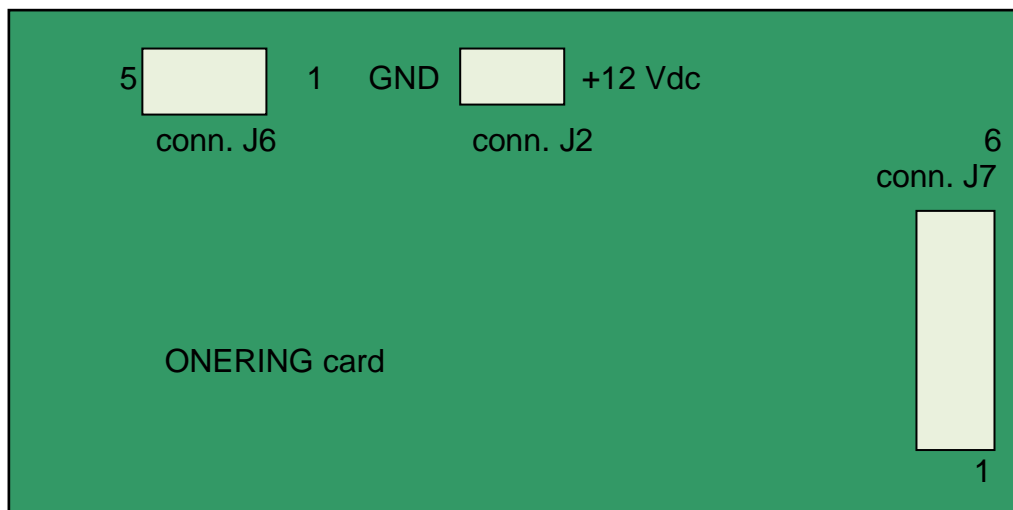

J7 Connector on TD542/C ONERING card

N. PIN	NAME	FUNCTIONALITY
1	CL side a	Bus L side A
2	CH side a	Bus H side A
3	Gnd/bus	Gnd bus ref.
4	Gnd/bus	Gnd bus ref.
5	CH side b	Bus H side B
6	CL side b	Bus L side B

J2 Connector on TD542/C ONERING card

N. PIN	NAME	FUNCTIONALITY
1	12Vdc	+ Power supply
2	GND	- Power supply

ONERING cards must be connected between each other as described below:

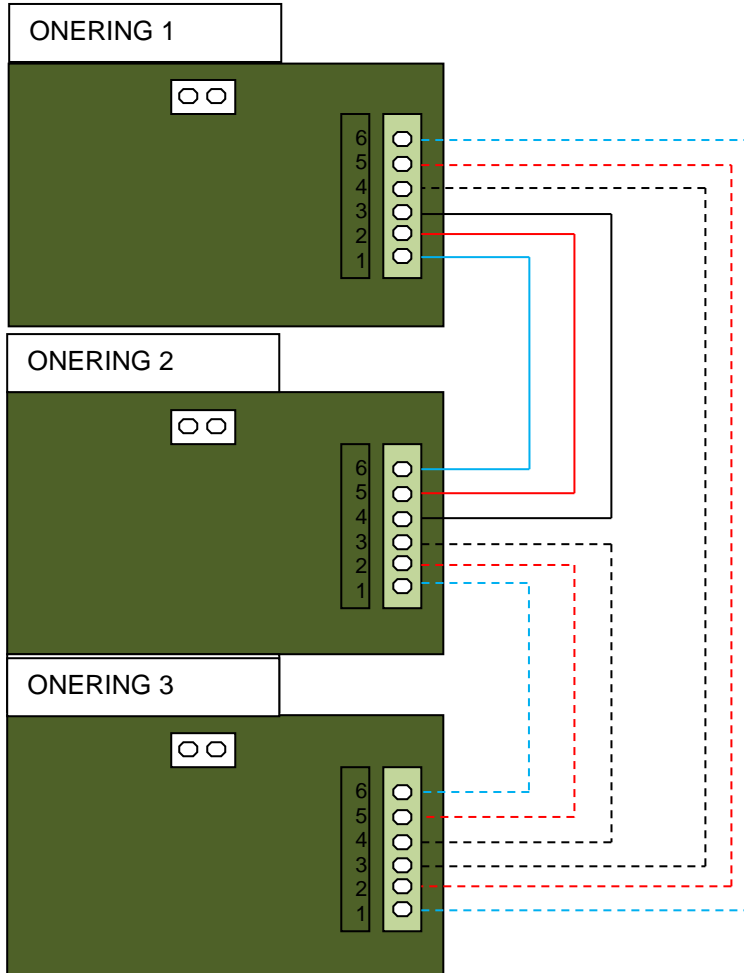

- CL A side of ONERING 1 to CL B side of ONERING 2
- CL A side of ONERING 2 to CL B side of ONERING 3, and so on until the ring is closed back to ONERING 1
- CH A side of ONERING 1 to CH B side of ONERING 2;
- CH A side of ONERING 2 to CH B side of ONERING 3, and so on until the ring is closed back to ONERING 1.
- Connect also the ground bus (GND) between two consecutive OLYNET cards



ONERING ring network is developed to ensure functionality also in case of a bus cut or short. The system is able to keep the data transfer between the panels in degraded mode, in case of power failure of one or more ONERING cards.



Check the bus connections before starting the system.

7.5 Power supplies and batteries

Inside Teledata One panel it is possible to install up to two ONEPW power supplies and can contain two 7.2Ah or 17 Ah batteries, depending on the expansion cards installed.

TeledataONE Main CPU TD571 (loop 1)	ONE2 Expansion n°1 TD574 (loop 2&3)	ONE2 Expansion n°2 TD574 (loop 4&5)	ONE2 Expansion n°3 TD574 (loop 6&7)	ONE2 Expansion n°4 TD574 (loop 8&9)	PT LAN (Ethernet 10 Base T interface)	ONERING Network interface	ONE56 Led Area	ONEPW	Batteries capacity	
										
X							X	X	1	7,2Ah/ 17Ah
X					X			X	1	7,2Ah/ 17Ah
X						X		X	1	7,2Ah/ 17Ah
X								X	1	17Ah
X	X						X	X	2	17Ah
X	X				X		X	X	2	17Ah
X	X						X	X	2	17Ah
X	X	X					X	X	2	17Ah
X	X	X					X	X	2	17Ah
X	X	X					X	X	2	17Ah
X	X	X					X	X	2	17Ah

Batteries must be cabled in series and blocked with the nylon wire wraps supplied.

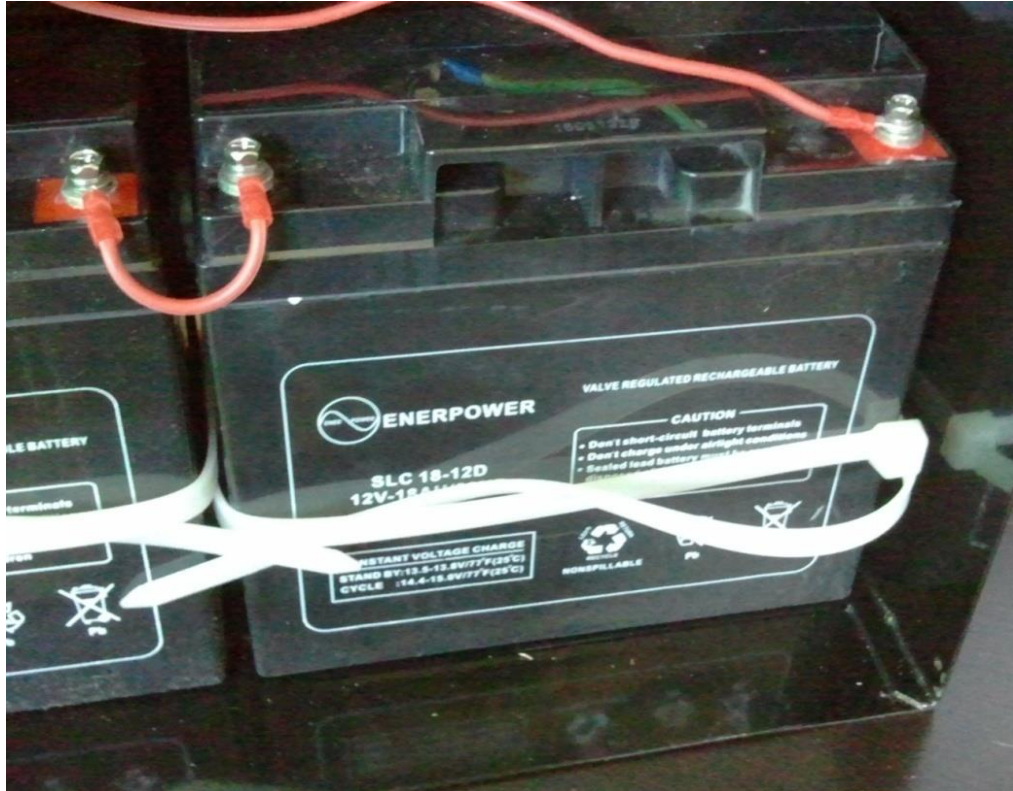

7.6 System description

Below is described a description of the control panel logic and of connections required to set-up the system.

7.6.1 Relations between the elements of the plant

The following picture shows the relations between the various elements that make up the plant managed by the control panel.

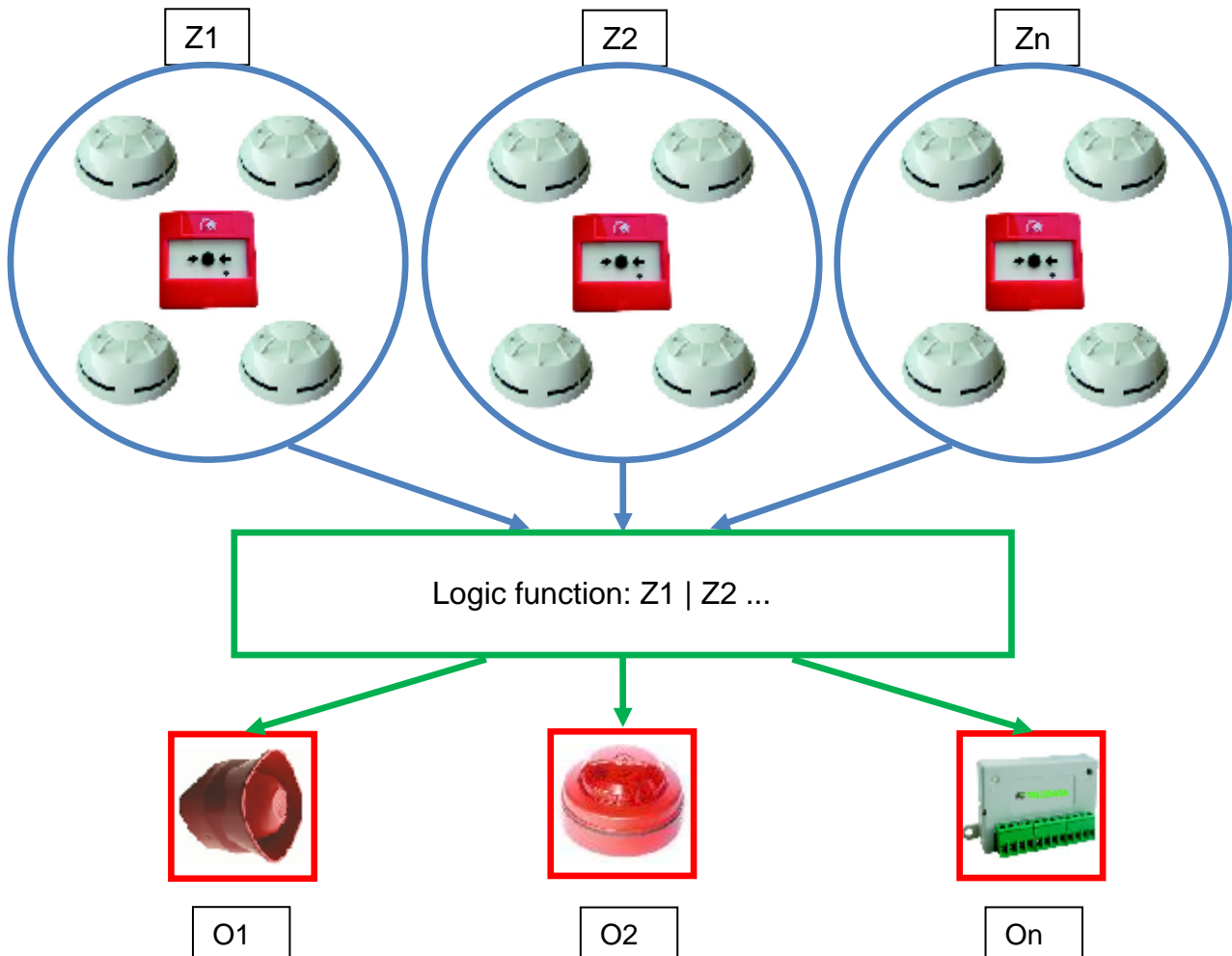

Devices (detectors, call points, etc.) are grouped in zones linked between them by specific logical functions that can activate one or more outputs.

7.6.2 Sounder and load connection

The outputs 5, 6 of the connector J4 are used to connect the loads (sounders, bells, optical acoustic displays) for which it is necessary to monitor the cut and the short.

The control panel is able to detect the presence of a cut or of a short circuit on the connection line of the loads. In the event of one of these cases the control panel will indicate it by an optical indication (message on the display, yellow LED for sounder fault is on) or acoustic signal (buzzer).

Follow the instructions below:

- Connect a 3.3kΩ ¼ Watt end of line resistance and a 1N4007 diode. Normally these resistors and diodes are provided with the control panel

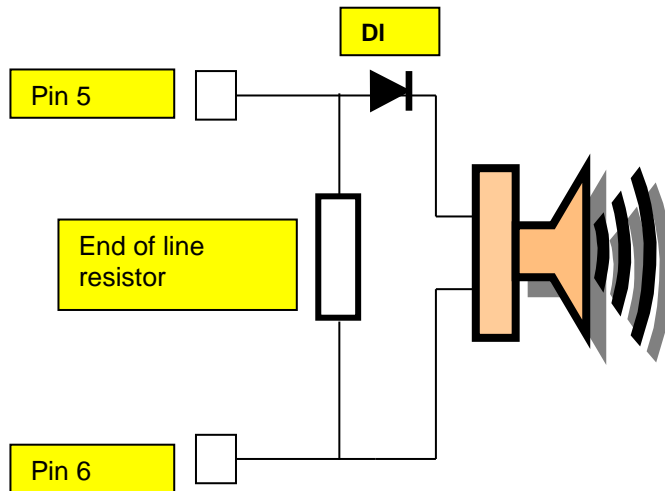

- Connect loads to the panel, use cables with a maximum resistance of 50 Ω.



The maximum current available is 500mA @ 27Vdc.

The diagnostics of these outputs is activated only when the load is deactivated, that is when the control panel does not report any alarm.

If load is used with internal protection diode, such as optical acoustic displays protected against inversion, the protection diode may be omitted.

7.7 Communication with detectors and modules

The TeledataONE control panel communicates with addressable detection and control devices through a two-wire line, called loop.

It is possible to use the control panel in open loop systems or closed loop systems.

According to the effective standards, in systems where there are more than 32 modules/detectors, it is necessary to use the closed loop configuration.

7.7.1 Open loop configuration

Below an example of open loop configuration.

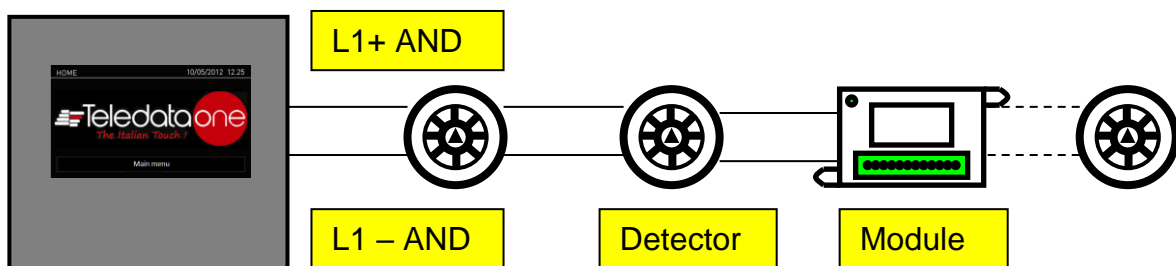

This configuration uses lines **L+** e **L-** on pins FW+ and FW- of connector J9.
 It is possible to connect up to 32 detectors and I/O modules.

7.7.2 Generic loop connection requirements

Match the following requirements:

- Twisted and shielded 2-conductor cable,
- Loop with only detectors, call points and modules, total line length should not exceed:

LENGTH	TYPE OF CABLE
Up to 1250mt	2x0.5mm ²
Up to 1850mt	2x0.75mm ²
Up to 2500mt	2x1mm ²
Up to 3500mt	2x1.5mm ²
Up to 5000mt	2x2.5mm ²

- Line resistance should not exceed 100Ω,
- Line cables installed on a dedicated path,
- Cables placed at a proper distance from the power lines.

7.7.3 Open loop configuration ("T" junctions)

Below an example of open loop configuration with "T" junctions.

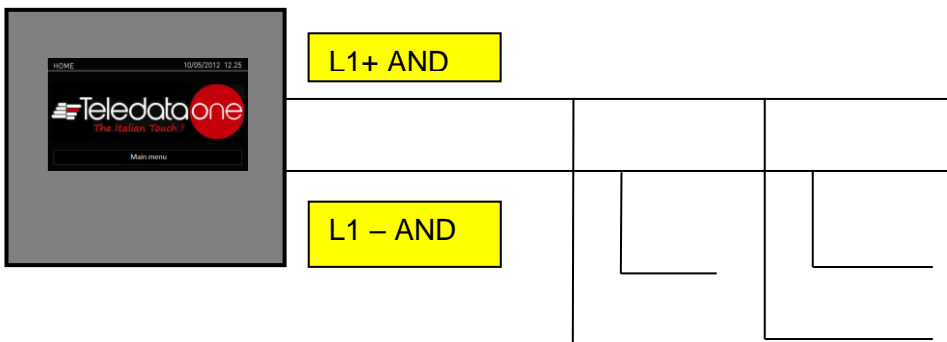

7.7.4 Open loop connection with "T" junctions connection requirements

Match the following requirements:

- The total length of all legs should not exceed the maximum allowed length, according to the section of the cable used,
- Total resistance from the control panel connectors to the end of every junction should not exceed 100Ω.

7.7.5 Closed loop configuration

Below an example of closed loop configuration.

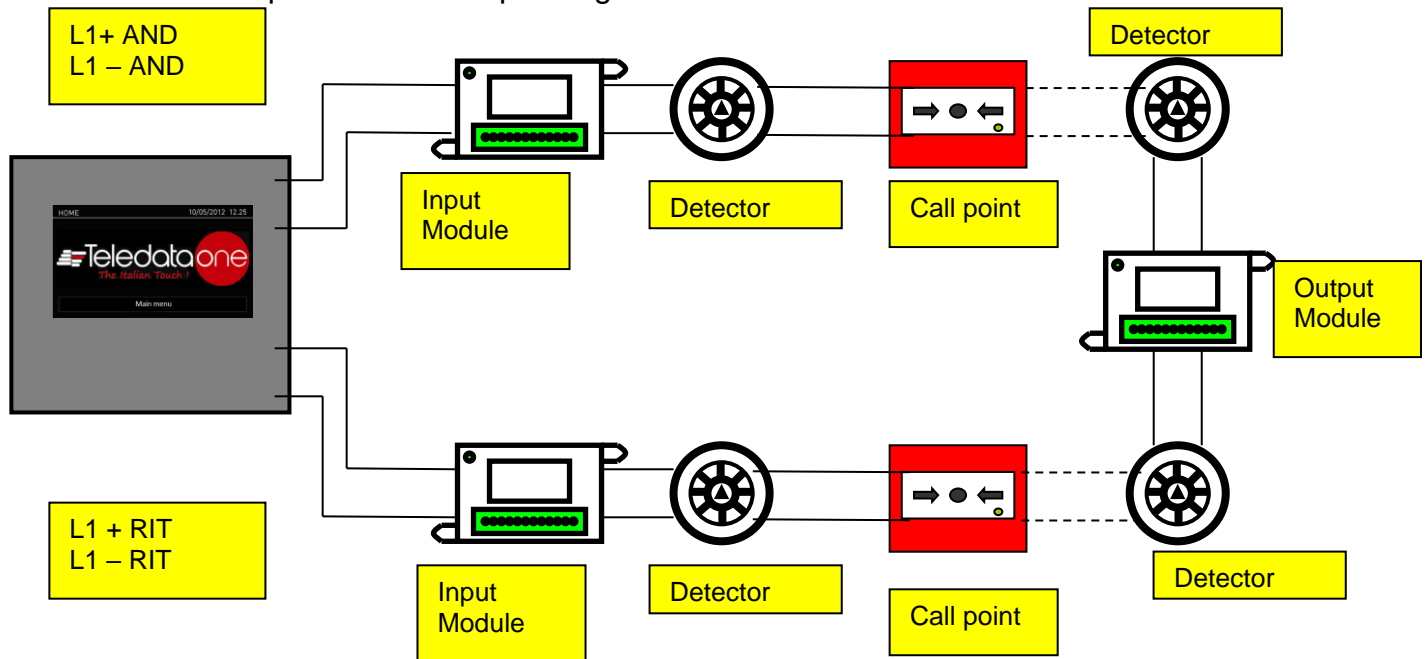

This type of configuration uses **L-** and **L+ FW** and **L-** and **L+ RET** lines of connector J9.

It is possible to connect up to 240 detectors and I/O modules.



If SFx000E type sensors are used, install an insulator module or sensor/module with on-board insulator for every 32 devices as required by current specifications.

7.7.6 Connection requirements for a closed loop connection

Match the following requirements:

- Total line length (between OUT and IN) should not exceed the maximum allowed length according to the section of the cable used.

7.7.7 Connectable loop devices

It is possible to connect the following ONE PROTOCOLL devices on the loop:

- ONEDETECTOR1 optical smoke detector
- ONEDETECTOR optical and rate of rise detector at 58 °C (class A1 and A1R)
- ONEDETECTOR2 temperature detector, (class A1R and B)
- ONECALLPOINT Addressable Manual call point
- ONEMODULE301 Addressable Module 3 inputs and 1 supervised output with short-circuit isolator
- ONEMODULE300 Addressable module 3 inputs with short circuit
- ONEMODULE111 Addressable Module 1 input 1 output form C 1 supervised output with short circuit isolator
- ONEMODULE120 Addressed module 1 input 2 output form C with short circuit isolator
- ONEMICROM10 Input micromodule with short circuit isolator

- ONEMICROM01 Output micromodule with short circuit isolator
- ONEMICROM11 Input and output micromodule with short circuit isolator
- SOUND100 Addressed siren EN 54 3 with short-circuit isolator
- SOUND101 Addressed siren EN 54 3 with flashing light and short-circuit isolator
- SOUND110 Siren addressed with flashing EN 54 3 and 23 and short-circuit isolator

All the above mentioned devices can be addressed by means of the appropriate programming tool **ONEPROGRAMMER**.

By means of the same tool it is also possible to read some basic parameters of the different devices.

For more information about this tool, please refer to its dedicated manual.

Follow the instructions below:

- All above mentioned devices are provided with an incorporated line insulator. This element, inside the devices, is connected to the line. It is therefore necessary to strictly observe the line wiring instructions (line-input, line-output) when any kind of device is going to be connected to the loop, as described in the data sheet attached to the device.
- It is necessary to strictly observe the instructions concerning the input/output loads connection described in the data sheet of all input/output devices (I/O modules)

It is possible to connect the following Argus protocol devices on the loop:

- SF5100 (40910-8) optical smoke detector
- SF5200 (40920-8) optical and rate of rise detector at 58 °C (class A1 and A1R)
- SF5300 (40930-8) temperature detector, (class A1R and B)
- SF5100E (IV100) (like SF1000 but without isolator)
- SF5200E (IV200) (like SF2000 but without isolator)
- SF5300E (LV350) (like SF3500 but without isolator)
- FDVCP500 (40800) call point
- FDMM10 (40100-m) supervised input module
- FDMM01S (40010-m) supervised output module
- FDMM02 (40002-m) form C output module
- FDS500 (40300) addressable sounder
- FDW2W transceiver for wireless devices
- FDMM12 (40102-m) Input/Output module
- FDMM11S (40110-m) supervised input/output module
- FDXMM11S (40110) supervised input/output module
- FDMC404 (40110) 4 input 4 output module
- FDMC602 (40602) 6 input 2 output module
- FDVCP500IP67 (40801) call point resettable allarm
- FDCWS100AV Electronic sounder with addressable flashing
- FDVFI100 (40330) Addressable LED flashing
- FDVMCZ500 (40500) Remote addressed indicator
- FDVBLS100/32 32 tone sounder

All the above mentioned devices can be addressed by means of the appropriate programming tool **FDVPU1000**.

By means of the same tool it is also possible to read some basic parameters of the different devices.

For more information about this tool, please refer to its dedicated manual.

Follow the instructions below:

- All above mentioned devices are provided with an incorporated line insulator. This element, inside the devices, is connected to the line. It is therefore necessary to strictly observe the line wiring instructions (line-input, line-output) when any kind of device is going to be connected to the loop, as described in the data sheet attached to the device.
- It is necessary to strictly observe the instructions concerning the input/output loads connection described in the data sheet of all input/output devices (I/O modules)

It is also possible to manage, by using FDW2W, the following wireless devices:

- SWF1000 optical smoke detector
- SWF2000 optical and rate of rise detector at 58 °C (class A1 and A1R)
- SWF3500 temperature detector, (class A1R and B)
- FDWVMI100 supervised input module
- FDWVMI120 output module
- FDWMCB100 battery powered output module
- FDSGLSP100 addressable sounder
- FDWCP100 call point

It's possible to connect the following Apollo's device on the loop:

Apollo Code	Protocol	Device description
IN/OUT modules		
55000-841	XP95	Modulo IN plus with input opto isolator
55000-843	XP95	IN Module
55000-847	XP95	IN/OUT Module
55000-849	XP95	Modulo OUT form C
55000-852	XP95	OUT Monitored Module
55000-845	XP95	Zone monitor alimented by Loop
55000-875	XP95	OUT Module form C
55000-760	XP95	Mini Switch Monitor
55000-589	XP95	IN/OUT module 3+3 without isolator
55000-588	XP95	IN/OUT Modulo 3+3 with isolator
55000-864	XP95	Zone monitor; alimentation by loop
Detector		
58000-600	Discovery	Optical detector Discovery
58000-700	Discovery	Multi Discovery
58000-400	Discovery	Temperature detector Discovery
58000-500	Discovery	Ion
55000-600	XP95	Optical detector XP95
55000-885	XP95	Multi XP95
55000-400	XP95	Temperature detector XP95 (55°)

55000-401	XP95	Temperature detector XP95 (90°)
55000-500	XP95	Ion
CALL POINT		
55200-905	XP95	Call point XP95
58200-910	Discovery	Call point Discovery
SA5900-908	XP/Dis/Core	Call Point
Bases		
45681-210	NA	Normal addressable base
45681-284	NA	Base with isolator
Audiovisual Discovery		
58000-005	Discovery	Ottic and acustic sounder
45681-393	Discovery	Sounder beacon base
58000-010	Discovery	Voice alarm
45681-702	Discovery	Base sounder
Audiovisual XP95		
55000-001==>012	XP95	Open area alarm device
58000-700	XP95	Base sounder Discovery / XP95
45681-277	XP95	Integrated base sounder Discovery /XP95
55000-877	XP95	Loop powered beacon
45681-276	NA	Ancillary base sounder
Soteria Detector		
SA5100-400	Coreprotocol	Temperature detector
SA5100-600	Coreprotocol	Optical detector
SA5100-700	Coreprotocol	Multi criteria
	Coreprotocol	MCP
Wireless XP95		
XPA-CB-12034-APO	XP95	XPander Optical Smoke Detector
XPA_CB-13032-APO	XP95	XPander Multisensorr Detector
XPA-CB-11170-APO		XPander Heat Detector Rate-of-Rise (A1R) & Static (CS)
XPA-CB-11171-APO	XP95	
XPA-CB-14001-APO		XPander Sounder (red) & (white)
XPA-CB-14002-APO	XP95	
XPA-CB-14003-APO		XPndr Sounder Vis Ind (red) Sounder Base (red) XPndr Sounder Vis Ind (amber) and Sounder Base (white) XPndr Sounder Vis Ind (clear) and Sounder Base (white)
XPA-CB-14004-APO		
XPA-CB-14005-APO	XP95	
XPA-MC-14006-APO	XP95	XPander Manual Call Point
XPA-IN-14011-APO	XP95	XPander Input/Output Single Unit
XPA-IN-14012-APO	XP95	XPander Input/Output Dual Unit
XPA-IN-14050-APO	XP95	XPander Diversity Loop Interface Unit
55000-540	XP95	IS Ion detector
55000-640	XP95	IS Optical detector
55000-440	XP95	IS Heat detector
55200-940	XP95	IS MCP
Flame detectors	XP95	All flame detectors
55000-268/274	XP95	Beam detectors

7.8 Connection to host computer

The control panel can be connected to a host computer by means of a Point2Point connection or online by means of an appropriate LAN interface.

7.8.1 Point2Point connection

Below an example of point-to-point connection.



These types of configuration can be carried out through serial port that connect the host computer directly to the control panel through the connector P1. A connection table is provided below.

Connection for boards TD571D and previous:

Central Side	Connection	PC side
7 Jumpered with 8		7 Jumpered with 8
4	Connection with	2
3	Connection with	3
1	Connection with	5

Connection for boards TD571E:

Central Side	Connection	PC side
7 Jumpered with 8		7 Jumpered with 8
2	Connection with	2
3	Connection with	3
5	Connection with	5

It can be used for point-to-point connections with the program host to download a new firmware version.

7.8.2 LAN or WAN connection

Below an example of network connection.

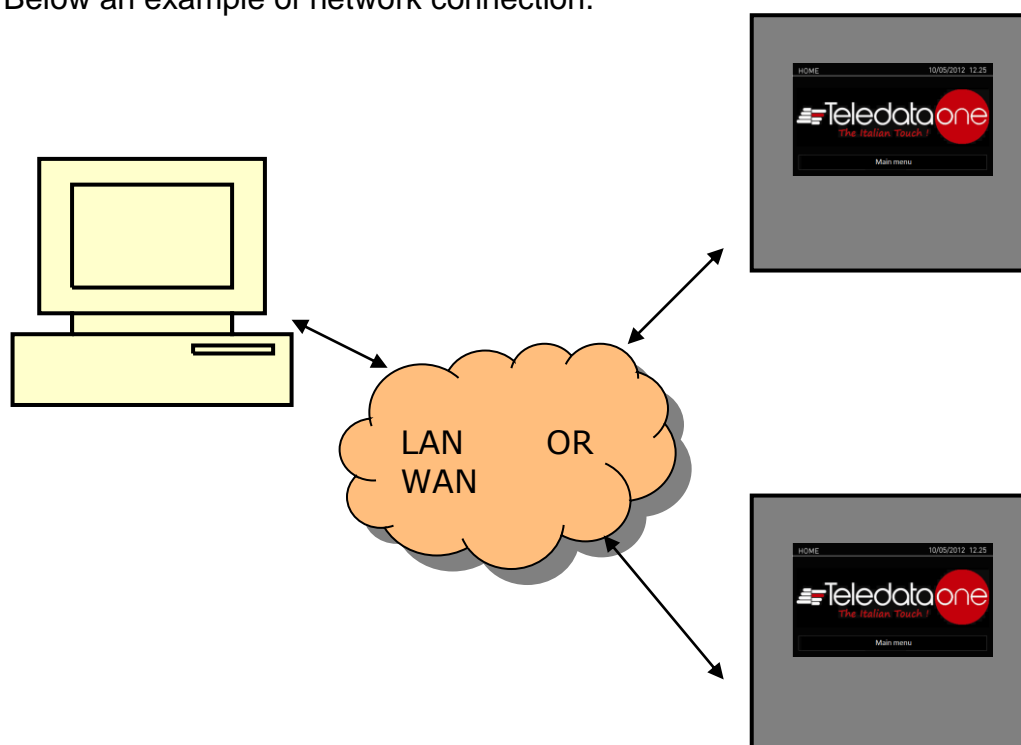

With this configuration it is possible to connect one or more control panel in a LAN or WAN environment and monitor them from a host provided with centralized supervision functionality.

7.8.3 Teledata One control panel ring network

More than one Teledata One control panel may be connected together in a ring network on a dedicated bus, by installing the optional ONERING network card.

In this network, events and alarms can be shared.

Below an example of ring network connection.

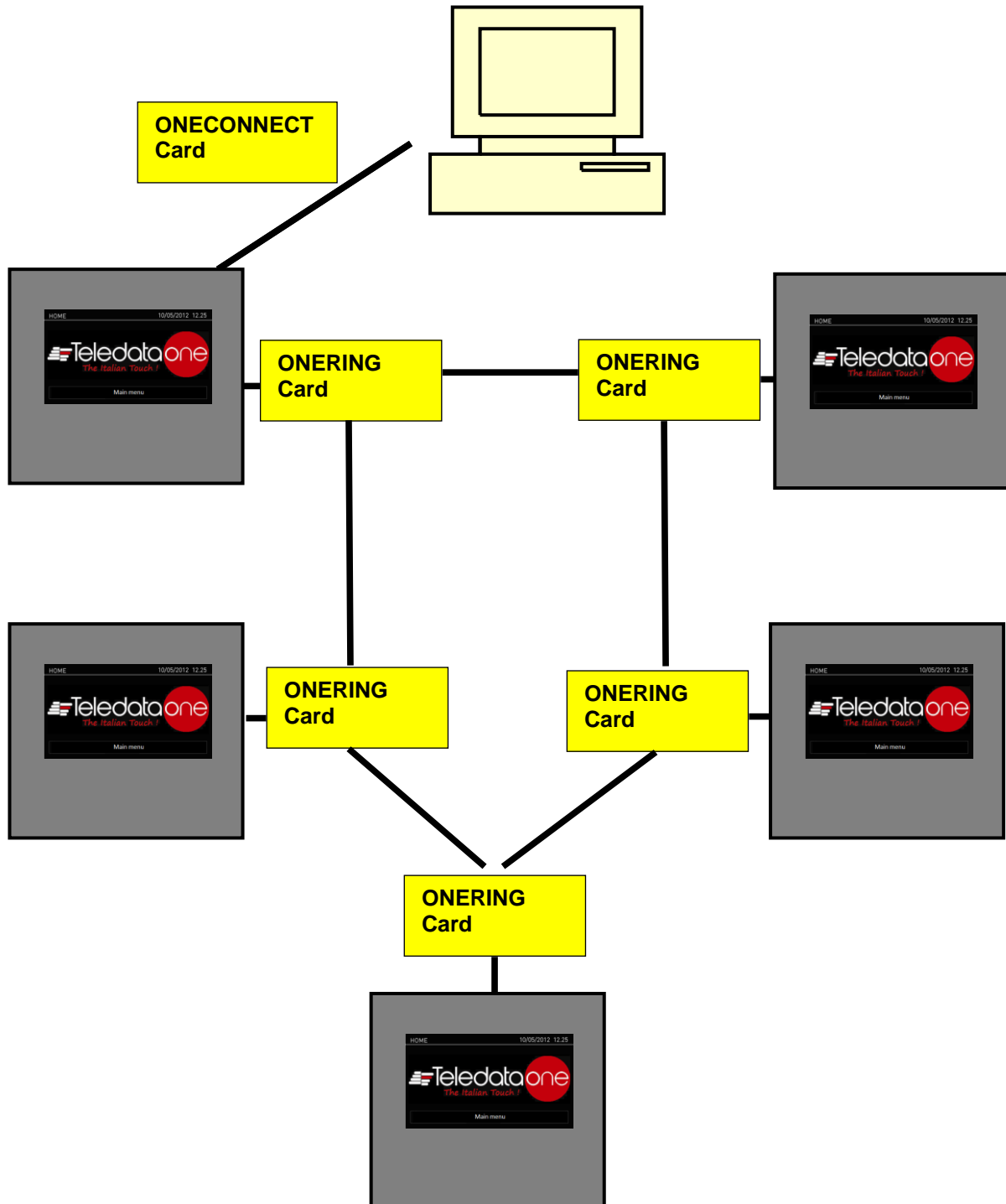

7.9 Power supply

7.9.1 Network input features

The control panel has to be installed according to the national installation standards.

It is requested to carry out a connection to a separated AC line that has to be marked with the label **FIRE SYSTEM**.

Use a double-pole switch minimum 6A.

The connection wires have to have a proper section area and a minimum insulation of **600V**.

The power supply input has to have the following features:

- Supply voltage 230 Vac +/- 10%
- Frequency 50/60 Hz

7.9.2 Grounding features

The grounding installation has to be carried out according to the CEI and ISPLES standards and with a resistance lower than **10Ω**.

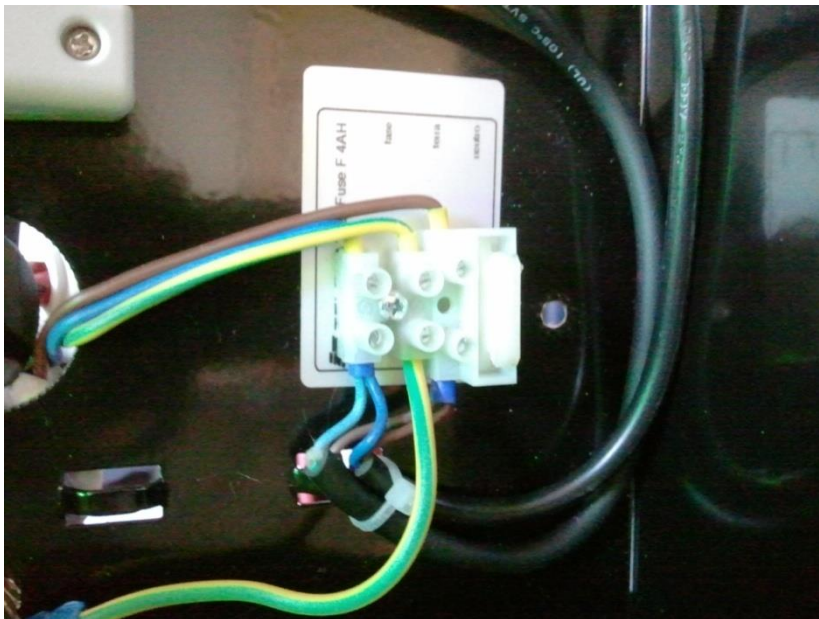

7.9.3 Panel power supply features

Following features are useful for the system installation:

- Output operating voltage 27.6 V - Max. 500mA
- Voltage of battery charger 27.6 V- Max. 900mA
- Low battery threshold 21.6 Volts
- Battery release threshold 20.4 Volts

The battery charger section works as follows:

- In case of power supply missing, the control panel is fed by the backup batteries. The green LED turns off.
- If the battery voltage drops below the low-battery threshold, an acoustic (buzzer) and visual (on-screen message) signal are activated
- In this situation, to restart the control panel, restore the network power supply.
- If no battery is installed, at the first battery control carried out periodically by the control panel, an acoustic (buzzer) and visual (on-screen message) signal are activated to signal that the batteries in the control panel are missing.
- If the battery's internal resistance (including the resistance due to contacts and cables) is higher than 800 mΩ, the control panel will emit an acoustic (buzzer) and optical (on-screen message) alarm.



The value of internal resistance is referred to 7,2Ah and 17Ah batteries.

As far as the operating +24 V power supply section for external loads is concerned:

- The voltage output is protected against short circuits.
- In case of a short circuit an acoustic (buzzer) and visual (on-screen message) signal is activated.

7.10 Panel internal cabling

The panel internal cabling has to be done in such way to be easily accessible in case of future maintenance.

The cables can enter into panel unit through the holes provided on the upper part of the box and on the back.

Cable outlet for 22 mm diameter must be use.

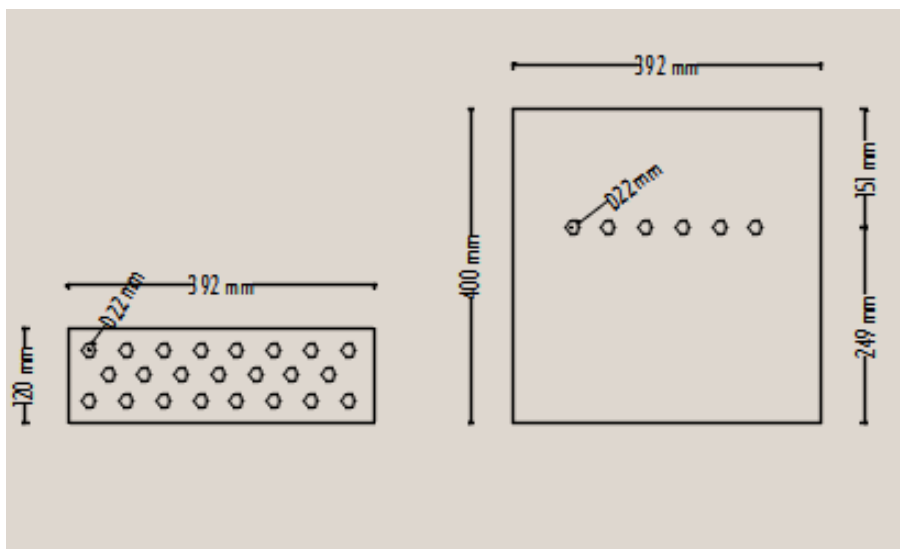

It is important to connect the cable shields to an earth terminal in the panel mechanics. For closed loops, connect only one side of the shield, leaving the other side disconnected.

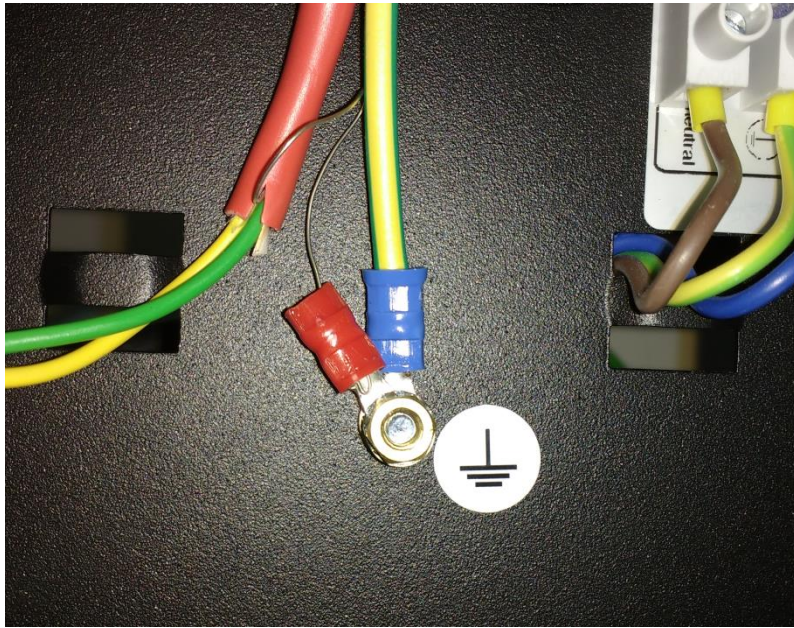

Below a cabling example of a complete panel is shown.

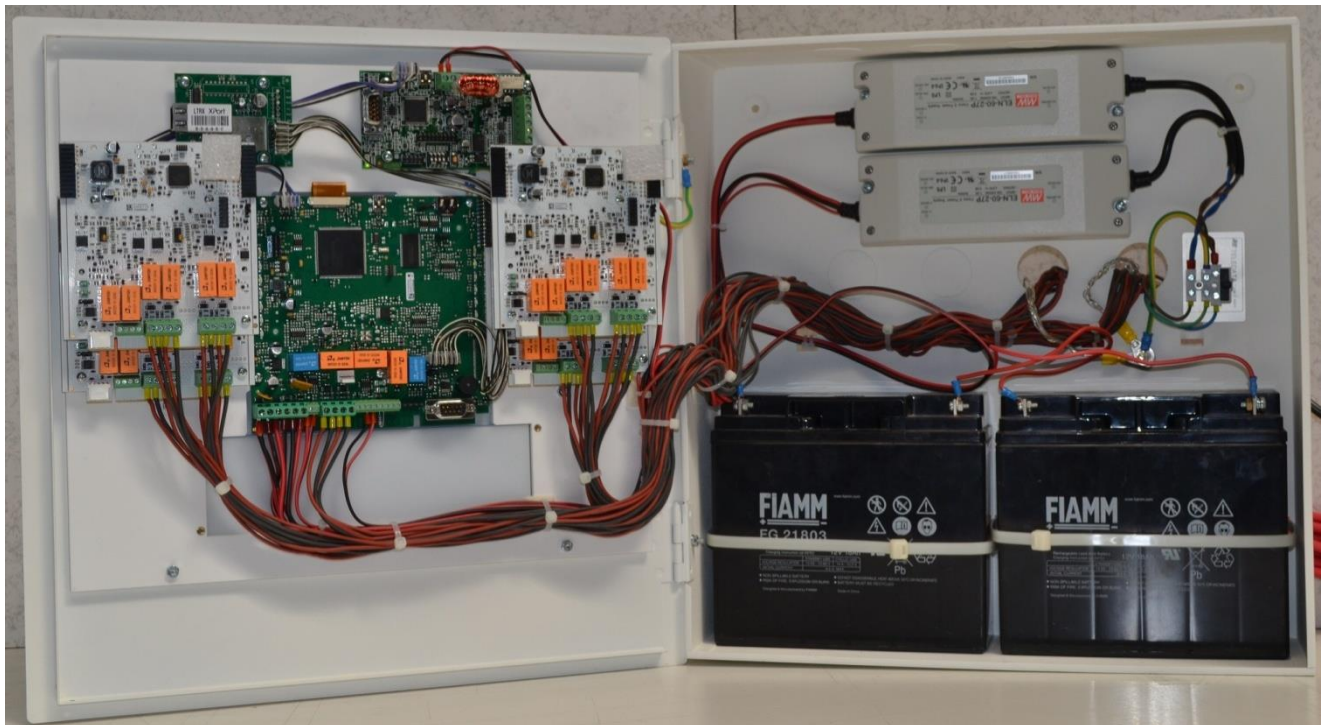

8. Control panel

The control panel includes the following elements:

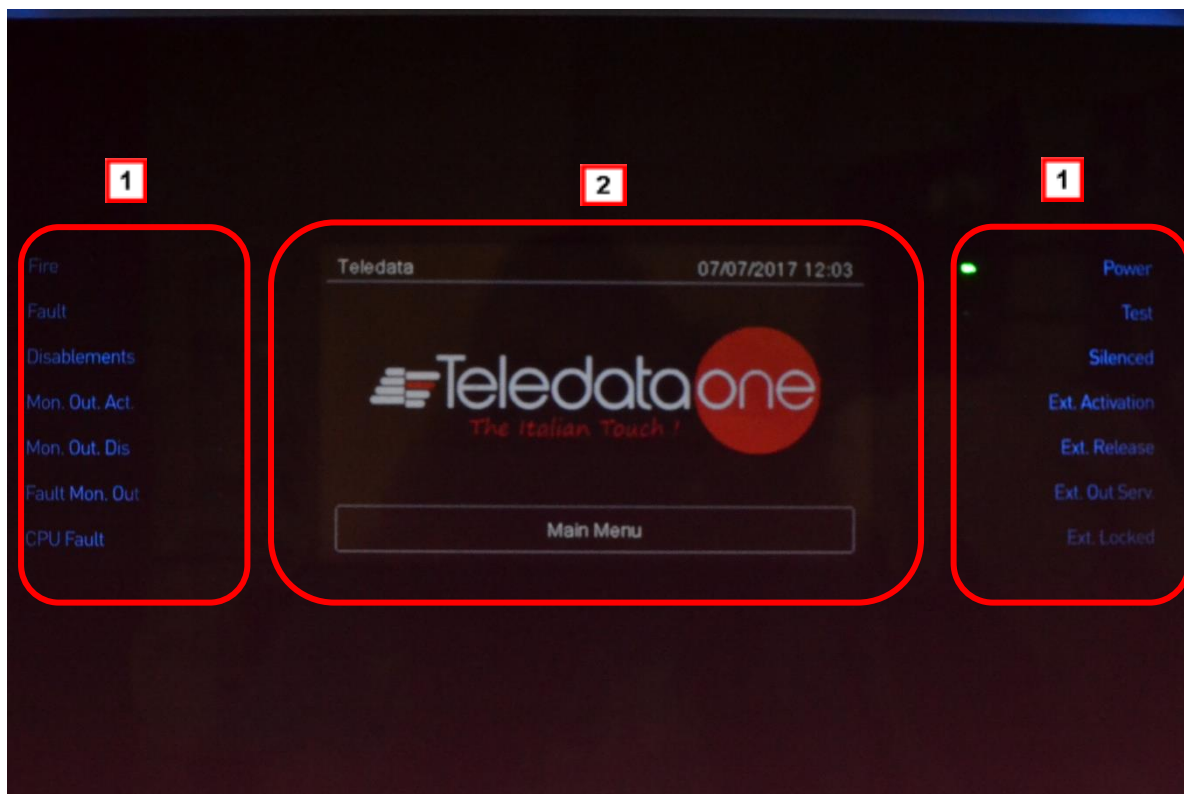

Area	Description
1	Status led
2	Graphic interface (touch screen)

8.1 Status led

The following led are on the control panel:

Name	Color	Description
Fire	Red	Fire alarm from at least a device in the system
Fault	Yellow	Generic fault
Disablements	Yellow	Devices or peripherals disabled
Mon. Out. Act.	Yellow	Monitored output activated
Mon Out. Dis.	Yellow	Monitored output disabled
Fault Mon. Out.	Yellow	Monitored output fault
CPU fault	Yellow	CPU fault
Power	Green	Main Power supply 220V
Test	Yellow	At least one device under test
Silenced	Yellow	Alarm silenced

Name	Color	Description
Ext. Activation	Yellow	Extinguishing circuit activated (not yet available)
Ext. Release	Yellow	Extinguishing circuit released (not yet available)
Ext. Out Serv.	Yellow	Extinguishing circuit fault (not yet available)
Ext. Locked	Yellow	Extinguishing circuit locked (not yet available)

8.2 Graphic interface

The following elements are always displayed in all menus:

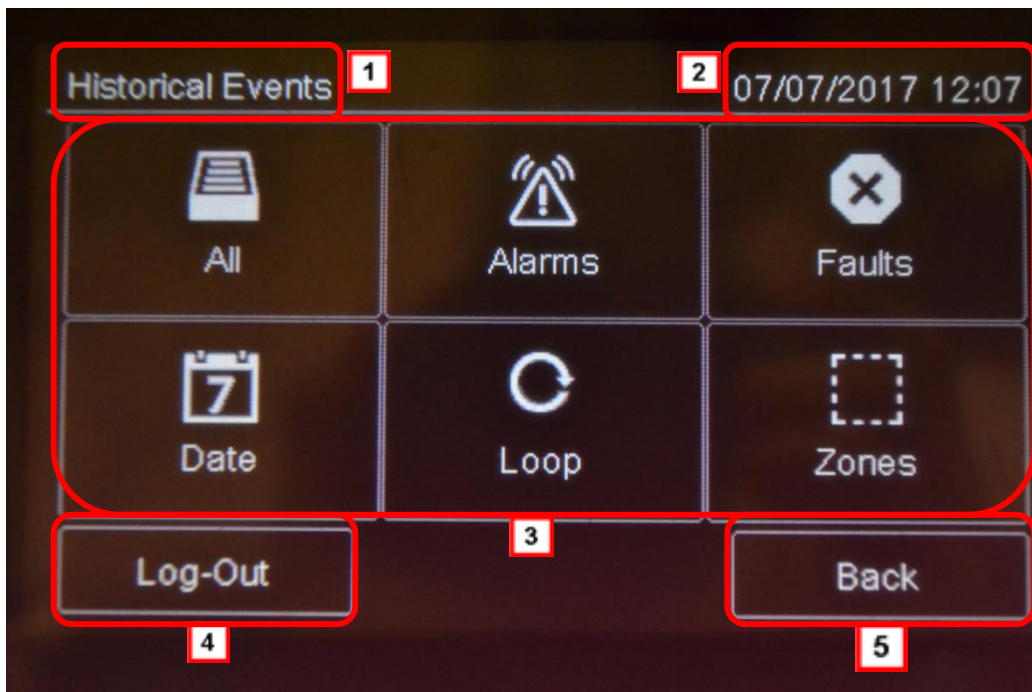

Area	Description
1	Page name
2	Unit date and time
3	Specific page content
4	Exit key
5	Back key

8.3 Types of users

The panel can be used by three different types of users:

- **User** that can:
 - view system events
 - silence the panel and alarms
 - reset the panel and alarms
 - disable devices

- test installed devices
- export log events to USB
- device diagnostics
- **Programmer** that can:
 - configure and initialize the unit
 - view system events
 - disable devices
 - test installed devices
 - add and configure new devices
 - modify the access credentials of all users
 - choose the type of loop to configure, if Apollo or Argus, if open or closed
 - select the panel language
 - see the general informations of the panel
 - add new expansion boards to the unit
- **Technical support** that can:
 - carry out all operations reserved to Technical support personnel.

Each operator can only open the screens required to run their permitted operations.

Any operator can view the system status and current events because these operations are directly accessible from the Main page which is not password protected.

8.4 Access levels

As described by EN54/2, there are four access levels to the control panel:

- **Level 1:** no access code is required
- **Level 2:** reserved to *Users* (up to maximum three operators); an access code is required
- **Level 3:** reserved to *Programmers*; an access code is required (and jumper JP3 must be closed)
- **Level 4:** reserved to *Technical support*; a wired PC connection is required.

9. Basic operations for any operator

9.1 View basic information

The home page is viewed when turned on if no events have occurred:



Press **Main Menu** to view it:

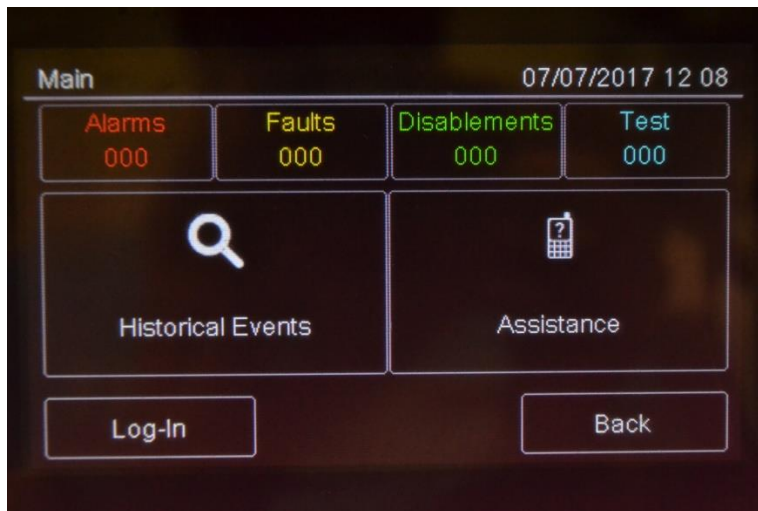

The menus in this page can be opened without entering any code.

Options

Menu	Function
Events	Opens the Events menu.
Assistance	Opens the Assistance page.

If any type of event has occurred, the **Current events** page is displayed when turned on.

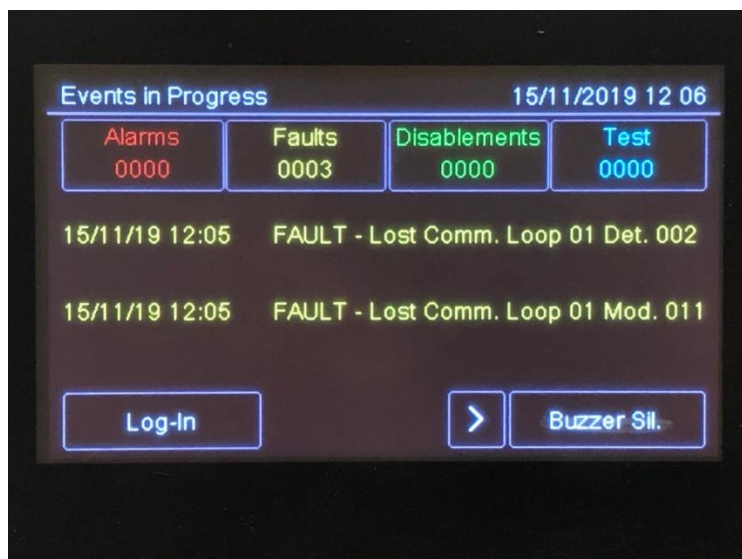

Fields

Field	Description
Alarms	Displays the number of devices in alarm.
Faults	Displays the number of devices in fault status.
Exclusion	Displays the number of devices disabled.
Test	Displays the number of devices under test.

Options

Option	Function
Log – in	To open unit functions with a login code.
< >	To scroll through the pages that display all events.
Silence	To mute the panel buzzer (but not device alarms).

9.1.1 Viewing events

Main menu -> Events 

The **Events** menu lets you view events logged by category.

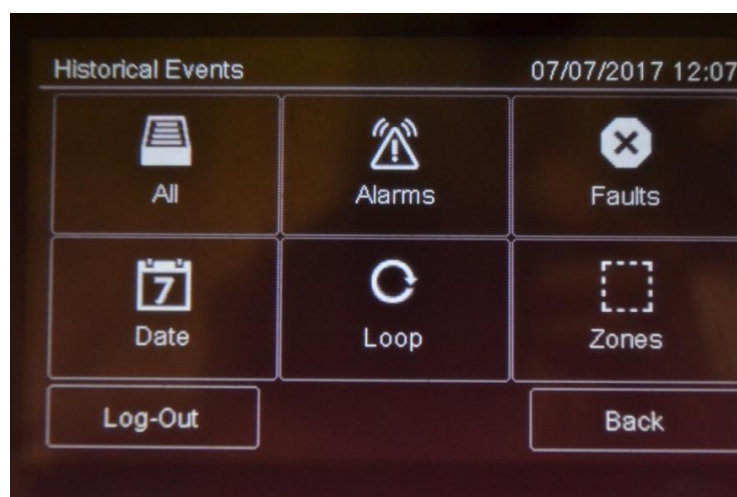

Procedures

To view all events:

- Select **All**: a list of all events is displayed.

To view all alarms:

- Select **Alarms**: a list of all alarms is displayed.

To view all faults:

- Select **Faults**: a list of all faults is displayed.

To view events on a specific day:

- Select **Date**: the **Log by Date** screen appears.
- Set the date of the events to be viewed.
- Press **Save** to confirm: all events on the selected day are displayed.

To view events in a specific loop:

- Select **Loop**: the **Log by Loop** screen appears.
- Select the loop of the events to be viewed.
- Press **Save** to confirm: all events in the selected loop are displayed.

To view events in a specific zone:

- Select **Zone**: the **Log by Zone** screen appears.
- Select the zone of the events to be viewed.
- Press **Save** to confirm: all events in the selected zone are displayed.



:it's possible to enter in Events menu choosing one of the box show in main page; we can only see the events related to the events choice.

9.1.2

Viewing assistance information



Main menu -> Assistance

Information required to receive assistance is displayed in this page.

9.2 Login

Main page -> Log-in

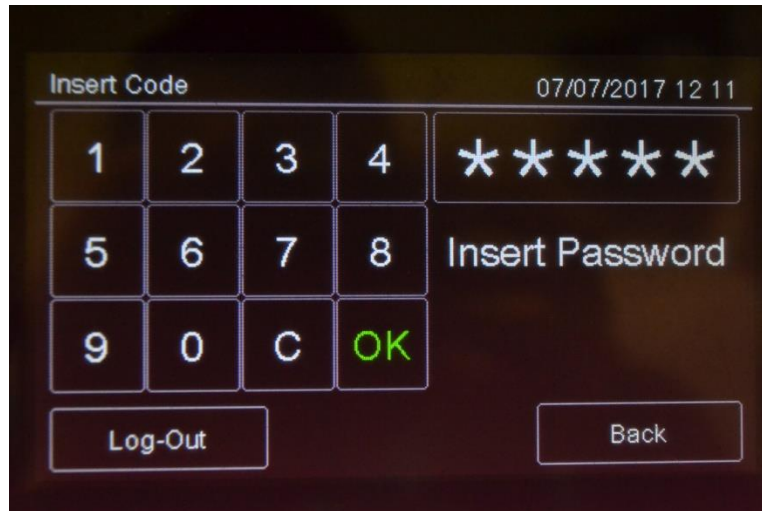

Default settings

The following codes are set by default:

- **User code:** 22222, 22223, 22224
- **Programmer code:** 33333



Default user profile passwords 22223 and 22224 are disabled. For instructions on how to enable them, see *Enabling users and changing login codes*).

Procedure

1. Insert the five digits of the code.
2. Press **OK** to confirm: the relevant menu is displayed according to the entered code.



Change the password as soon as possible to avoid unauthorized access to the system (see *11.2 Enabling users and changing login codes*).

User menu

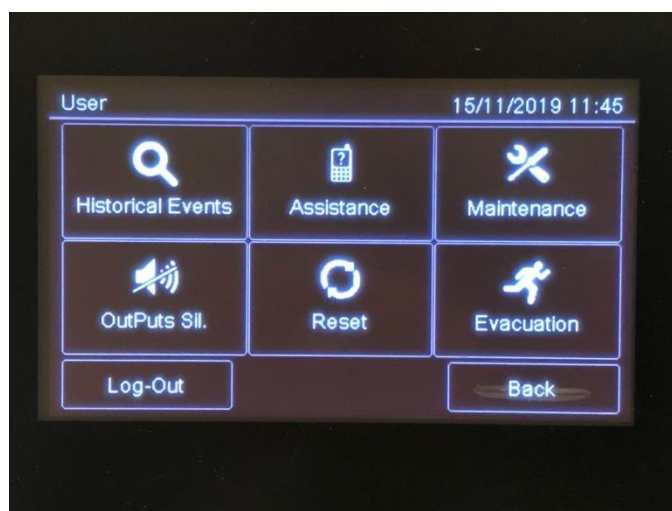

Programming menu

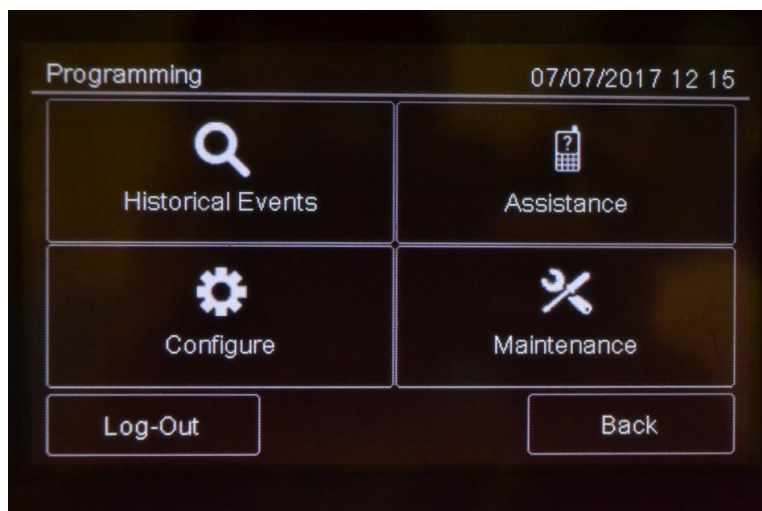

Procedures used by the various operators who work on the unit are described below.



This icon identifies functions reserved to the User.



This icon identifies functions reserved to the Programmer.

10. Configuration



The functions described below can only be run by authorized operators who have a specific system login code to the task to be performed.

10.1 Setting up the panel



The following functions are reserved to the Programmer.

To set up the panel after installation:

- set the number of installed expansion boards,
- set device addresses,
- set connected device names and features,
- group devices in zones,
- set relations between zones,
- create logic functions to turn on outputs,
- set output activation,
- set the calendar.

10.1.1 Setting up expansion boards

Programming menu -> Configure -> System -> Additional Cards -> Loop

This function lets you specify how many ONE2 additional boards are installed on the panel.



Note: each expansion board contains other 2 addressed loops.

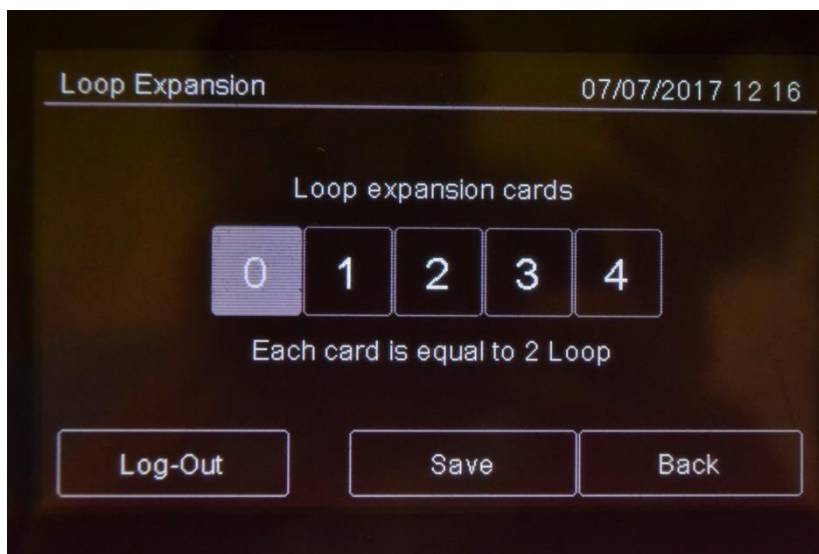

Procedure

1. Select the number of additional boards on the unit.
2. Press **Save** to confirm.

To remove an ONE2 additional card, press again onto the quantity set.

10.1.2 Programming Menu -> Configure -> System -> Additional Cards -> Onering 

This function allows to configure all the necessary parameters for the correct functionality of the OlyNet system. In order to have this functionality, it is necessary to have installed in the panel an OneRing additional card, and the panel is connected into a ring with other TeledataONE or Olympia panels.

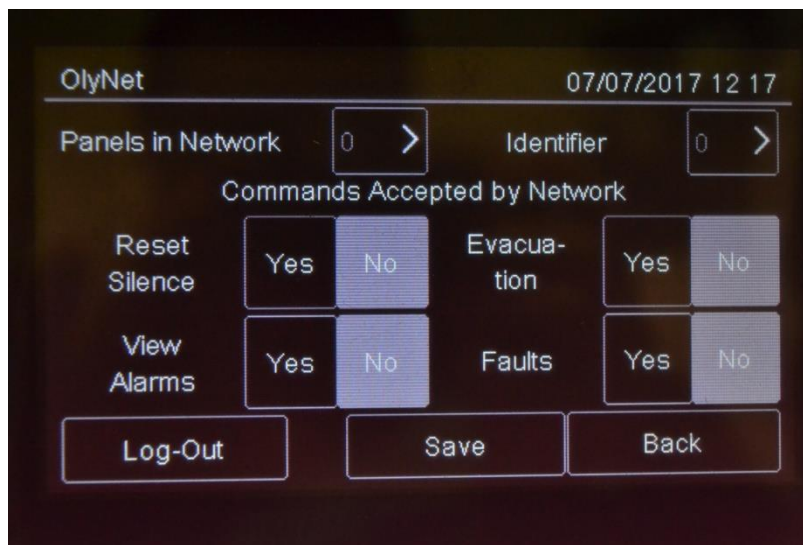

Procedure

1. Select the quantity of panels connected into the ring.
2. Select the single panel and confirm the model and the quantity of loops used.
3. Set the ID of the panel being configured.
4. Set the commands accepted from the network.
5. Press **Save** to confirm.

10.1.3 Selection of the loop protocol

When switched on for the first time, the panel will ask which type of protocol you'll be using.

The selection will be between Argus and Apollo

10.1.4 Run auto-addressing

Programming menu -> Configure -> Auto Addr. 

This function will automatically set an address to all devices connected to the panel, without using the hand programmer.

10.1.5 Run self-programming



Programming menu -> Configure -> Auto Progr.

This function will search for and save all devices connected to the panel.

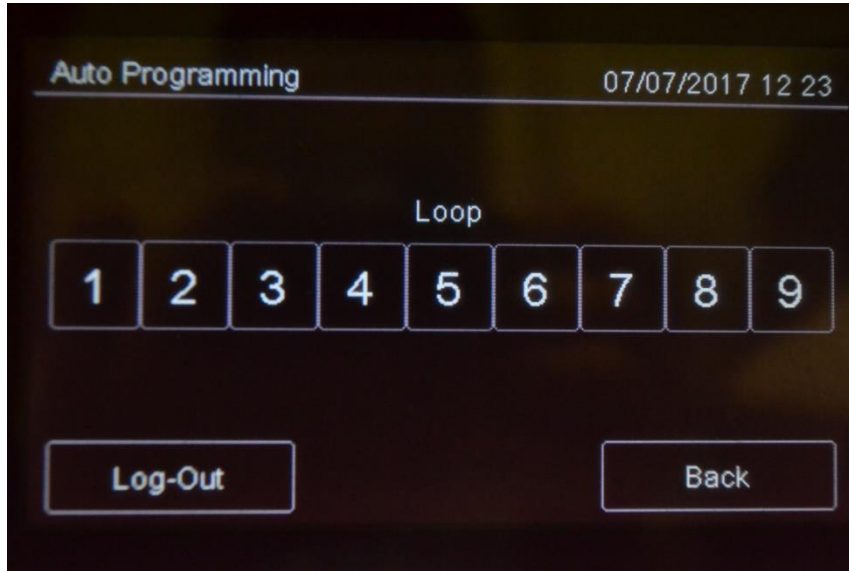

Procedure

Select the required loop: self-programming will start and the found devices will be displayed as illustrated in the example.



10.2 All In All Out configuration

Programming menu -> Configure -> Devices/Zones -> All In All Out

This is a security mode feature that permit to have activation of all the outputs before to finish causes and effects configuration.

By default All In All Out set is enable, so at the first input alarm, all output will be activated.

When program is completed and checked, this set can be changed on disabled.

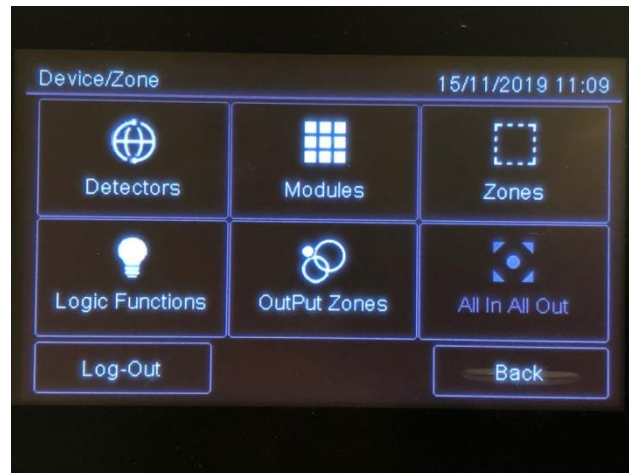

When general setting of this parameter is changed , all outputs follow this status

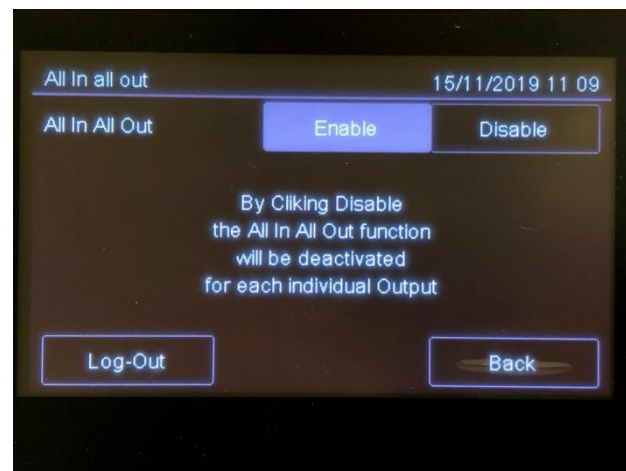

It's possible activate for single output device this functionality. (see 10.4)

10.3 Detectors configuration



The following functions are reserved to the Programmer.



Programming menu -> Configure -> Devices/Zones -> Detectors

With this function it is possible to:

- add a detector
- edit an already added detector
- copy a detector settings to one or more consecutive detectors
- delete a detector

Settings

Detector parameters to be set are described below.

Parameter	Description
Name	Detector identification name
Type	Type of connected detector (Optical, Thermal, Optical/Thermal)
Radio	Identifies wireless devices. With wireless devices, an FDW2W wireless translator must be installed.
Verify Alarms	Enables an alarm verification procedure, for an amount of time that can be programmed using parameter Verify seconds .
Verify seconds	Interval, in seconds, during which the detector has to remain in alarm before the panel will display the fire alarm. If set to zero, the panel will go to alarm status only when it receives three consecutive alarms from the detector within 60 seconds from the arrival of the first one. The first two alarms received will be ignored by the panel and will reset the detector.
Slave sounder	This setting change led remote output of detector to work as output of panel. If this is set as YES follow settings compare: Activate Evacuation: This output follow Evacuation command All In All Out: This output follow AIAO security activation mode Silenceable: This Output follow out silence / rearm command
Sensitivity management (only for smoke detectors)	24 H: the level of sensitivity remains the set one for the entire day. Night: sensitivity increases by one step during the night. Fixed: fixed sensitivity set to Medium High. If the Night management is selected, it is also necessary to set the Weekly Trend parameter.
Sensitivity	Detector level of sensitivity (Low, Medium Low, Medium High, High)
Weekly trend	Sets the weekly trend for the detector sensitivity management. (see <i>Setting weekly trends</i>).

Parameter	Description
Deactivate part (only for multi detector)	Day: select the part to deactivate it (smoke or thermal) Night: select the part to deactivate it (smoke or thermal) If this feature is used, it is also necessary to set the Weekly Trend parameter.
Weekly trend	Sets the weekly trend for the deactivation of part of the detector. (see <i>10.9.5 Setting weekly trends</i>).

Procedures

To add a sensor:

1. Select the **Add** option: a list of loops in the system is displayed.
2. Select the loop where the sensor has to be added: a list of sensors in the loop is displayed.
3. Select an unused sensor number: the sensor settings window is displayed.
4. Enter the required settings.
5. Press **Next** to move to the next screen.
6. Press **Save** to confirm.

To edit a sensor:

1. Select the **Edit** option: a list of loops in the system is displayed.
2. Select the loop that contains the sensor.
3. Select the required sensor.
4. Edit settings.
5. Press **Save** to confirm.

To delete a sensor:

1. Select the **Delete** option: a list of loops in the system is displayed.
2. Select the loop that contains the sensor.
3. To delete a single sensor, press the sensor twice.
4. To delete several consecutive sensors, press the first and last module in the interval.
5. Press **Save** to delete the sensor or sensors.

To copy a sensor:

1. Select the **Copy** option: a list of loops in the system is displayed.
2. Select the loop that contains the sensor to be copied
3. Select the sensor to copy settings from.
4. Select the first sensor in the group to copy settings to.
5. Select the last sensor in the group to copy settings to.
6. Press **Save** to apply settings to all selected sensors.

10.4 Modules configuration



The following functions are reserved to the Programmer.



Programming menu -> Configure -> Devices/Zones -> Modules

This function lets you:

- add a module
- edit an already added module
- copy a module settings to one or more consecutive modules
- delete a module

Settings

Following are the parameters to be set for all types of modules.

Parameter	Description
Name	Module identification name
Radio	Identifies wireless devices. With wireless devices, a FDW2W wireless converter must be installed.
Type	Module type: Argus:(Input, Output, Expander); Apollo: (input, output, expander ,multi 1+1, multi 2+2, multi 3+3)

Following are the parameters to be set for an **Input** type module.

Parameter	Description
Type	Module type (Input, Call point Gas)
Alarm test	Enables an alarm verification procedure, for an amount of time that can be programmed using parameter Verify seconds .
Test seconds	Interval, in seconds, during which the detector has to remain in alarm before the panel will displayed the fire alarm. If set to zero, the panel will go to alarm status only when it receives three consecutive alarms from the detector within 60 seconds from the arrival of the first one. The first two alarms received will be ignores by the panel and will resets the detector.
Strength alarm	This setting give to input to be able to reset T1 and T2 timer for protected or not protected mode of the zones and activate outputs
Technological	Identifies the alarm signal as "technological" and thus less critical. Setting a module like technologic, it's possible setting other 3 functions: Fault, Self Restore and Pre-Alarm

Fault	Event to control is interpreted from panel as fault and for that is managed. It is shown in the display Fault-Technology that has occurred on the programmed module.
Self restore	This function allows the automatic reset of the central once the 'input falls in the stand-by condition. It is activated in case of technological monitoring or fault.
Pre-alarm	Turns on the pre-alarm function When a pre-alarm event is detected: all output modules associated with the output zones where the pre-alarm was triggered are turned on (see <i>10.6 Output zones</i>), the unit red led blinks, if the pre-alarm is not reset during the pre-alarm time or an alarm triggers, the panel red led turns on.

Following are the additional parameters for an input module from the version 3.1.X on

Parameter	Description
Type	Module type (Input, Call point).
Reset Command	When an input is set with this parameter, it will work as the reset command on the user level,
Silence command	When an input is set with this parameter, it will work as the silence command on the user level.
Key	An input set as a key is capable of enabling and disabling other devices of the loop,
Parameters for the key	
Impulsive	Each time the input is alarmed, it will send the associated command. In case of an enable/disable key, it will change the state of the associated devices each time is activated.
On/Off	The signal of disable/enable will be sent once the input is alarmed and restored.
Enable/Disable	The input is capable of both enabling and disabling the devices
Only enable	The input can only enable the already disabled devices
Only disable	The input can only disable the already enabled devices
Enable from reset command	When set on YES : the devices disabled by this input will be enabled after a reset SW. When set on NO : the devices disabled by the input can only be enabled manually.

Following are the parameters to be set for an **Output** type module.

Parameter	Description
Type	Module type (Output, Flasher, Siren, Repeater LED).
Reset sensors	This feature is usually used to reset conventional devices that are not connected directly to the loop. Every time that the panel is reset, this output will be activated for around 5 seconds.

Parameter	Description
All In All Out:	This output follow AIAO security activation mode
Silenceable	This Output follow out silence / rearm command
Activate Evacuation	If activated, this feature will activate the output in case of an user evacuation command, also if its zone or the logic function where it is linked is not yet valid.
For Siren type modules only	
Volume	(only for siren model FDVBS100/32 or FDVBS100-AV/32) Siren volume level, also set the tone.

Following are the additional parameters for the outputs from the version 3.1.x on

Parameter	Description
Type	Module type (Output, Flasher, Repeater LED).
Or Fault	When a fault appears on the panel, the output activates, and goes back to its rest state only when the counter of the faults goes back to 0. To select this parameter it is necessary to disable all the other functions of the output (All in All out, silenceable, active evacuation, reset detectors)
Or Disabling	When a disabling is done on the panel, the output activates, and goes back to its rest state only when the counter of the disabling goes back to 0. To select this parameter it is necessary to disable all the other functions of the output (All in All out, silenceable, active evacuation, reset detectors)
Or Test	When a test is done on the panel, the output activates, and goes back to its rest state only when the counter of the test goes back to 0. To select this parameter it is necessary to disable all the other functions of the output (All in All out, silenceable, active evacuation, reset detectors)

Following are the parameters to be set for Multi I/O

Parameter	Description
Type	Module type (Multi I/O 1+1,Multi I/O 2+2,Multi I/O 3+3).
Choose device	This function is used to set devices for each line of input and output from the form: we will have two devices (one inbound and one outbound) if the Multi I / O is 1 + 1, 4 devices (two input and two outgoing) if the Multi I / O is 2 + 2, finally 6 devices (three input and three output) if the Multi I / O is 3 + 3.
Input type	Type of input module that can be inserted (input, throttle button)
Output type	Type of output module that can be inserted (output, flash, siren, led.rip.)



: it is important to remember that multiple modules occupy multiple addresses, depending on whether 1 + 1, 2 + 2 or 3 + 3; this because the input / output occupy additional subsequent virtual address to the address of the physical module.

Procedures

To add a module:

1. Select the **Add** option: a list of loops in the system is displayed.
2. Select the loop where the module is to be added: a list of all devices in use, both modules and sensors, in the loop is displayed.
3. Select an unused module number (blank): the module settings window is displayed.
4. Enter the required settings.
5. Press **Next** to move to the next screen.
6. Press **Save** to confirm.

To edit a module:

1. Select the **Edit** option: a list of loops in the system is displayed.
2. Select the loop that contains the module.
3. Select the required module.
4. Edit settings.
5. Press **Save** to confirm.

To delete a module:

1. Select the **Delete** option: a list of loops in the system is displayed.
2. Select the loop that contains the module.
3. To delete a single module, press the module twice.
4. To delete several consecutive modules, press the first and last module in the interval.
5. Press **Save** to delete the module or modules.

To copy a module:

This function lets you apply settings for one module to several consecutive modules:

1. Select the **Copy** option: a list of loops in the system is displayed.
2. Select the loop that contains the module to be copied
3. Select the module to copy settings from.
4. Select the first module in the group to copy settings to.
5. Select the last module in the group to copy settings to.
6. Press **Save** to apply settings to all selected modules

10.5 Zones configuration



The following functions are reserved to the Programmer.



Tip: before starting these operations, make sure you have understood how the various system elements interact. See *7.6.1 Relations between the elements of the plant.*

Programming menu -> Configure -> Devices/Zones -> Zones



A zone is a list of devices and events that are necessary to generate partitions of the system. It is possible to link devices, loops, and events to a zone.

This function lets you:

- link events, loops and devices to the the zones
- set various zone operating parameters
- link output modules to a zone

10.5.1 Link an event to a zoneSettings

Settings are described below.

Parameter	Description
Alarm	The zone is activated by an alarm of the linked devices.
Fault	The zone is activated by a fault of the linked devices.
Technol.	The zone is activated by a "technological" event of the linked devices.
Coincidence	Programmable by event, this parameter is the number of events that have to be recorded in order to activate the zone.

Procedure

1. Select the **Add** option: a list of zones in the system is displayed.
2. Select the required zone.
3. Select the **Events** option.
4. Select the events and their coincidence to be linked to the zone.
5. Press **Save** to confirm.

10.5.2 Linking loops to zones

Settings

Settings are described below.

Parameter	Description
All system	If Yes , all system devices will be linked to the zone. If No , select the loop that activates the zone.
Loop	Select the entire loop that will be associated with the programmed zone.

Procedure

1. Select the **Add** option: a list of zones in the system is displayed.
2. Select the required zone.
3. Select the **Loop** option.
4. Set the required parameters:
5. Press **Save** to confirm.

10.5.3 Linking devices to zones

Procedure

1. Select the **Add** option: a list of zones in the system is displayed.
2. Select the required zone.
3. Select the **Device** option.
4. Select the required loop: all devices in the loop are displayed.
5. Select all devices to be linked to the zone.
(A device can be added to 12 different zones at the same time)
6. Press **Back** to save the selection.

10.5.4 Set zone operating parameters

This function lets you set weekly zone behavior. This is helpful to bypass the unit on certain days or at certain times.

Settings

Settings are described below.

Parameter	Description
Zone name	Name assigned to the zone
Weekly trend Autoexclusion	Weekly trend linked to the zone. (see 10.9.5 Setting weekly trends).
protected	If set to Yes, you can set the times T1, T2, T2B and set the weekly survey of trends.
T1	It is the warning phase; in the moment of its activation, the area is already in alarm but the associated output are still not parties.
Output zone	It is possible to associate an output zone to T1: said output zone can be programmed to be activated immediately or after a delay. Functionality available from the version 3.1.x on.
T2	And the investigation time to physically check the veracity alarm; T2B has the same operation, but only if the warning comes from a button.
weekly trend survey	By setting this parameter, you can program the zone protected or unprotected during the week.

Procedure

1. Select the **Add** option: a list of zones in the system is displayed.
2. Select the required zone.
3. Select the **Settings** option.
4. Enter the required settings.
5. Press **Save** to confirm.

To verify that a zone is properly set as **protected**, also follow the following procedure:

1. Enter third level code 33333;
2. Select the Configure section;
3. Enter the System section;
4. Press the General Section;
5. Enter the Various section;
6. Verify that The terminals T1 and T2 are enabled; (Section 10.7.10 of this manual)
7. Perform the Log-Out;
8. Enter the second level code 22222;
9. Select the Maintenance section;
10. Select the Exclusions section;

11. Entering the section **protected**;
12. Verify that the area we have planned as **protected** is green

10.5.5 Link an output module to a zone

This function lets you directly link output modules to a zone. When the zone is triggered, the output modules automatically turn on.

The maximum number of outputs that can be added on a Zone is 60

Procedures

To add a zone:

1. Select the **Add** option: a list of zones in the system is displayed.
2. Select the required zone.
3. Select the **Output Modules** option.
4. Select the output module loop.
5. Select the required module.
6. Set the required parameters:
7. Press **Save** to confirm.

To edit a zone:

1. Select the **Edit** option: a list of zones in the system is displayed.
2. Select the zone to be edited.
3. To edit linked events see *10.5.1 Link an event to a zone* for parameter descriptions.
4. To edit linked loops: see 0
5. for parameter descriptions.
6. To edit linked devices see *10.5.3 Linking devices to zones* for parameter descriptions.
7. To edit operating parameters: see *10.5.4* for parameter descriptions.
8. To edit output modules: see *10.5.5 Link an output module to a zone* for parameter descriptions.

To delete a zone:

1. Select the **Delete** option: a list of zones in the system is displayed.
2. Select the zone to be deleted
3. To delete a single zone, press the zone twice.
4. To delete several consecutive zones, press the first and last zone in the interval.
5. Press **Save** to delete the zone.

10.6 Output zones configuration



The following functions are reserved to the Programmer.



Programming menu -> Configure -> Devices/Zones -> Output Zones

This function lets you link output modules to output zones.

The maximum number of outputs that can be added on Output Zone is 60

Settings

Settings are described below.

Parameter	Description
Activations	Event type that activates the zone (Alarm, Pre-alarm Gas)

Procedures

To create an output zone:

1. Select the **Add** option: a list of output zones in the system is displayed.
2. Select the first available output zone.
3. Set the required parameters:
4. Press **Next** to continue.
5. Select the loop that includes the output module to be linked.
6. Select the output module to be linked to the output zone.
7. Press **Save** to confirm.

To edit an output zone:

1. Select the **Edit** option: a list of output zones in the system is displayed.
2. Select the output zone to be edited.
3. Edit settings.
4. for parameter descriptions.
5. Press **Save** to confirm.

To delete an output zone:

1. Select the **Delete** option: a list of output zones in the system is displayed.
2. Select the output zone to be deleted
3. Press **Save** to delete the output zone.

10.7 Logic functions configuration



The following functions are reserved to the Programmer.



Programming menu -> Configure -> Devices/Zones -> Logic functions

Logic functions are cause and effect relations between events that occur in the panel. Logic functions can put the following into relation:

- detectors
- modules
- zones
- alarms coming from the Onering system
- events (not yet available)
- logic functions

For example, you can create a logic function in which the activation of a series of zones (inputs) activates specific outputs.

Logic operators

It is possible to link various inputs by using these logic operators:

- AND
- OR
- NOT
- XOR

Example of how to use logic operators

For each operator, below you can find an example of how they work. In these examples only two inputs elements were considered.

AND

A	B	Y
0	0	0
0	1	0
1	0	0
1	1	1

OR

A	B	Y
0	0	0
0	1	1
1	0	1
1	1	1

NOT

A	Y
0	1
1	0

XOR

A	B	Y
0	0	0
0	1	1
1	0	1
1	1	0

Settings

Settings are described below.

Parameter	Description
Detectors	Member loop and address
Modules	Member loop and address
Zone	Zone number
Onering	Select the interested panel and the necessary device (detector, module, zone, ecc)
Event	Select the event type. Detector: <ul style="list-style-type: none"> • Allarm • Fault • Disablements Module: <ul style="list-style-type: none"> • Allarm • Pre-Allarm • Fault • Disablements • Technological
Logic function	Number of another logic function that activates this one.
Delay	Delay time, in seconds, between logic function activation and output activation.
Length	Output activation time, in seconds. If set to 0000, the outputs will remain active until the operator will reset them.
Output Zone Associate	Outputs activated by logic functions. These outputs must already be programmed (see <i>10.6 Output zones</i>).

Procedures

To create a logic function:

1. Select the **Add** option: a list of available logic functions is displayed.
2. Select the first available logic function: the page where the logic function can be built appears.



3. Press the input that will activate the logic function. The windows required to identify the device, event or logic function appear according to the selected input.
4. For devices only, select the input status that will activate the function.
5. Build the logic relations between the events.

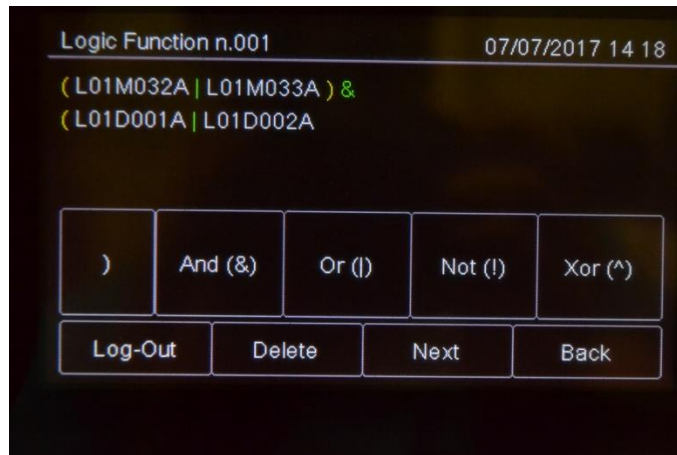

In the example, the logic function will be activated when sensor 001 in loop 1 triggers an alarm and detector 009 in loop 1 is in pre-alarm.

6. Press **Next** to move to the next window.

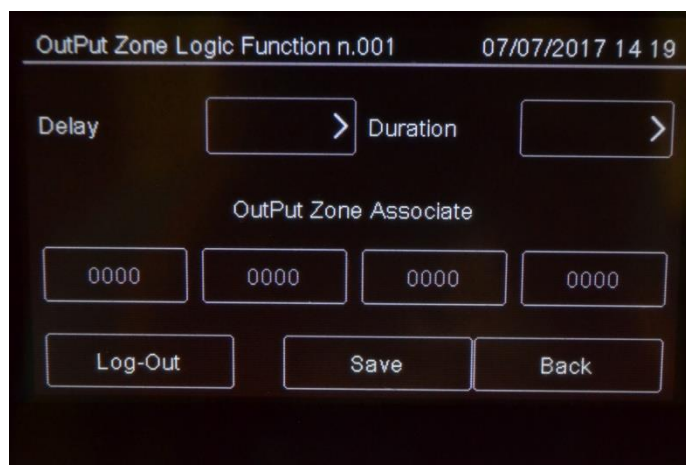

7. Set the required parameters.
8. Associate Output Zone

9. Press **Save** to confirm.

To edit a logic function:

1. Select the **Edit** option: a list of available logic functions is displayed.
2. Select the logic function to be edited.
3. Edit settings.
4. Press **Save** to confirm.

To delete a logic function:

1. Select the **Delete** option: a list of available logic functions is displayed.
2. Select the logic function to be deleted
3. Press **Save** to delete the logic function.

10.8 Setting system parameters



The following functions are reserved to the Programmer.

10.8.1 Setting the language



Programming menu -> Configure -> System -> General ->

Select the required language: the selected language is immediately applied.

The available languages (from version 3.0A07) are:

- Italian
- English
- Turkish
- French
- Farsi
- Arabic
- Polish
- Estonian
- Romanian
- Portuguese
- Danish
- Slovenian
- Dutch
- Singapore
- Hebrew
- Chinese
- Lithuanian
- Spanish

10.8.2 Entering panel information



Programming menu -> Configure -> System -> General -> Panel info



The screenshot shows the 'Panel Info' configuration screen. At the top right, the date and time '07/07/2017 14 19' are displayed. The screen contains several fields and buttons:

- Panel Name:** A text field containing 'Teledata' with a right-pointing arrow.
- Support Center:** A text field containing 'Teledata Milano +39 0227201352' with a right-pointing arrow.
- Background:** Three buttons labeled 'Black', 'Blue', and 'Green'. The 'Black' button is currently selected and highlighted.
- Logo Costum:** Two buttons labeled 'Teledata' and 'Background'.
- Log-Out:** A button at the bottom left.
- Back:** A button at the bottom right.

Settings

Settings are described below.

Parameter	Description
Panel name	Name assigned to the unit
Support center	Service center contact data
Background	Control panel background color (black, blue, green)
Logo Custom	Insert the password to personalize the panel with the customized logo.

10.8.3 Setting led and buzzer behavior

Programming menu -> Configure -> System -> General -> Buzzer-led

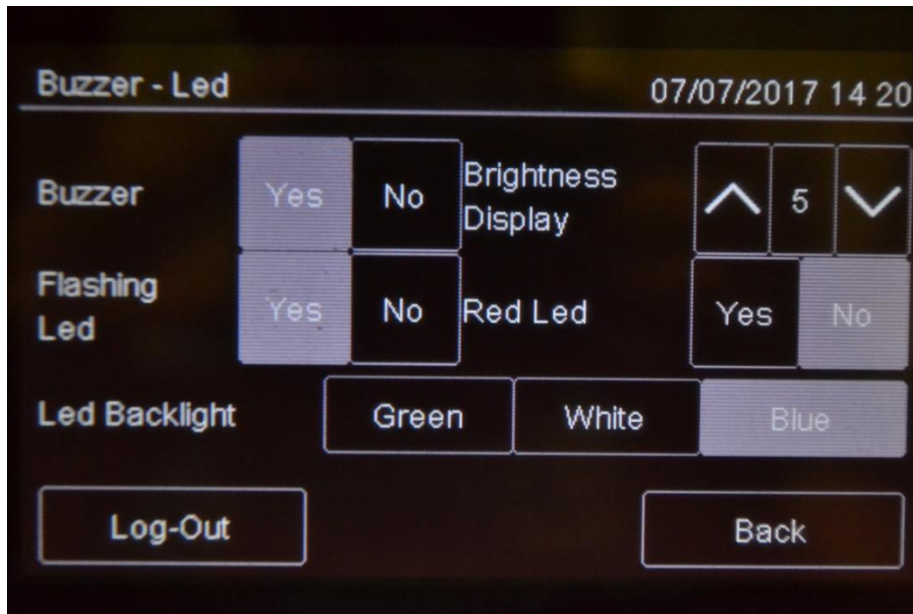

Settings

Settings are described below.

Parameter	Description
Buzzer	Enables the panels buzzer. The buzzer sounds in the event of fault or alarm.
Blinking led	Activates the blinking led function on devices installed on the loop. The led blinks when queried by the panel.
Red led	Sets the device led blink color to red. The led blinks when queried by the panel.  Activate in systems with sensors without built-in insulator, like SFxxxxE series..

Parameter	Description
Led Backlight	Sets the panels back light color (green, white, blue). Press the set colour to deactivate the LED backlight.

10.8.4 Setting remote communications



Programming menu -> Settings -> System -> General -> Supervision

This function lets you set parameters for communications with the unit via LAN or RS-232. This way the unit can be remotely monitored or programmed.

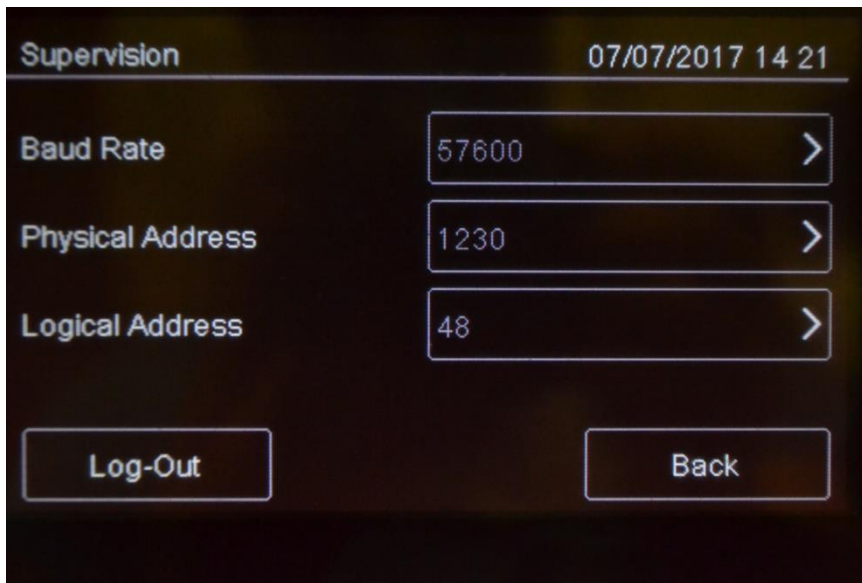

Settings

Settings are described below.

Parameter	Description
Baud Rate	Select one of the available options (9600, 19200, 38400, 57600). Select the highest value for faster connections. If a PT-LAN network card is installed, set the same parameter for the network card.
Physical address	Physical supervisor address
Logic address	Logic supervisor address



Make sure the same values are set on the supervisor.

10.8.5 Setting loop features

Programming menu -> Configure -> System -> General -> Loop type



This function lets you specify for each loop in the system whether the loop is closed or open.

Procedure

1. Set the type of each loop.
2. Press **Save** to confirm.

10.8.6 Restoring factory settings

Programming menu -> Configure -> System -> Values Factory



This function lets you restore factory settings.



Once this procedure is launched it cannot be interrupted, all setting changes will be deleted.

10.8.7 Setting peripheral features

Programming menu -> Configure -> System -> Peripherals



Here is possible to set peripherals on RS 485.

Remote Keypads (maximum number 16)

Remote Mimic Panels (maximum number 16)

10.8.8 Exporting data

Programming menu -> Configure -> System -> USB -> Export



This function will allow to export various data from the panel to a USB support.



The panel is compatible with USB supports with a capacity until 16Gb formatted in FAT32 with 4096 byte allocation table. It is necessary to format the device in such way with a PC.



Procedure

- Insert a compatible USB support by using a MiniUSB to USB adaptor.
- Select “Configuration”, a file will be saved on the USB support in own format not modifiable, with name “ONELOOP.CFG”.

If a file called “ONELOOP.CFG” is already existing in the inserted USB support root, it will be overwritten, losing any previous past data exportation. Exporting time is around 3 seconds.

- Selecting “Events”, a .csv format file will be saved on the USB support, that can be opened with a software like Excel, called “EVNTLOG.CSV”.

If a file called “EVNTLOG.CSV” is already existing in the inserted USB support root, it will be overwritten, losing any previous past data exportation. Exporting time depends on the amount of events in memory. A panel with a full memory is around 60 seconds.

- Selecting “Diagnostics”, it is necessary to select also the desired loop.
- On the USB support a .csv format file will be created, that can be opened with a software like Excel, called “1DIAGLP.CSV”, where the number in front of the file is the selected loop of the panel.

If a file called “xDIAGLP.CSV” is already existing in the inserted USB support root, it will be overwritten, losing any previous past data exportation. Exporting time depends on the amount of devices connected to the desired loop. A loop with 240 devices connected, the exporting time is around 240 seconds.



To avoid data corruption, do not disconnect the USB support, do not stop the exporting procedure and do not turn off the panel.

10.8.9 Importing data

Programming menu -> Configure -> System -> USB -> Import 

This function will allow to import a previously saved configuration, file from a USB support to the panel.

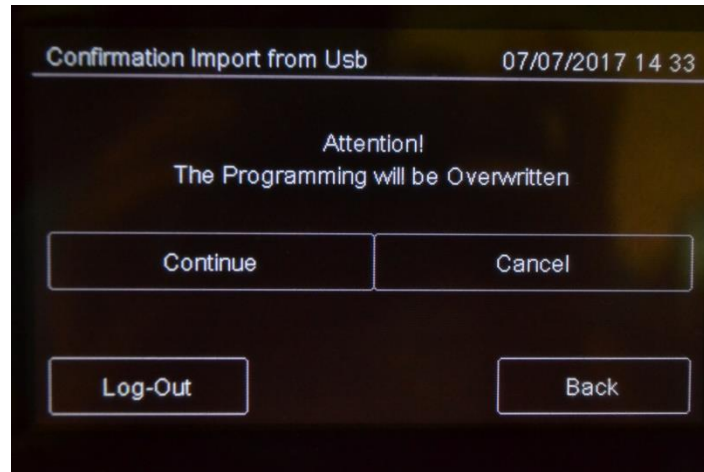

The panel is compatible with USB supports with a capacity until 16Gb formatted in FAT32 with 4096 byte allocation table. It is necessary to format the device in such way with a PC.

A configuration file called "ONELOOP.CFG" has to be existing in the inserted USB support root. The panel configuration will be overwritten with the one in the USB support. The importing time is around 20 seconds. After the importing, the panel will restart with the new configuration.



To avoid data corruption, do not disconnect the USB support, do not stop the exporting procedure and do not turn off the panel.

10.8.10 Various system settings



Programming menu -> Configure -> System -> General -> Various

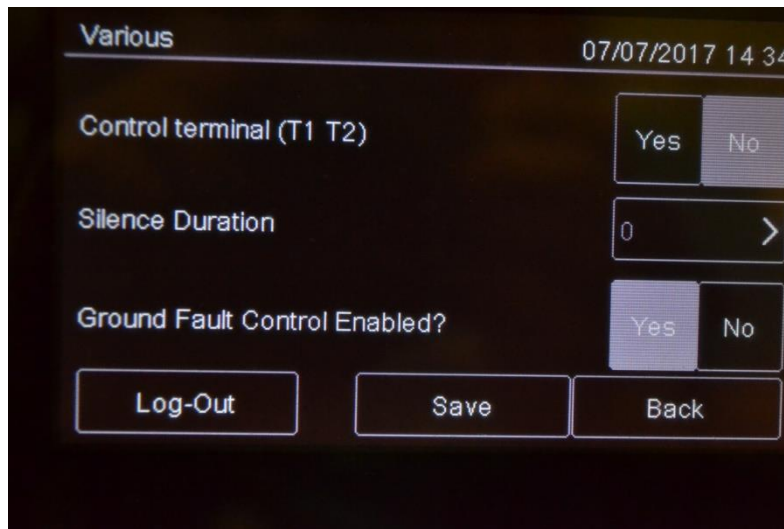

Settings

Settings are described below.

Parameter	Description
T1& T2 control	This parameter set if panel can control T1&T2 procedure or not
Silencing time	Buzzer mute time in the event of persistent alarm. The buzzer restarts after this time if the alarm is not reset.
Ground Fault Control	<p>Runs the ground fault test to check for mains power ground dispersions and loop signal grounding.</p> <p> Activate this option to debug installation errors, especially short circuits between grounding and unit signals (such as, for example, a contact between cable shield and conductor).</p>

10.9 Setting the calendar.



The following functions are reserved to the Programmer.

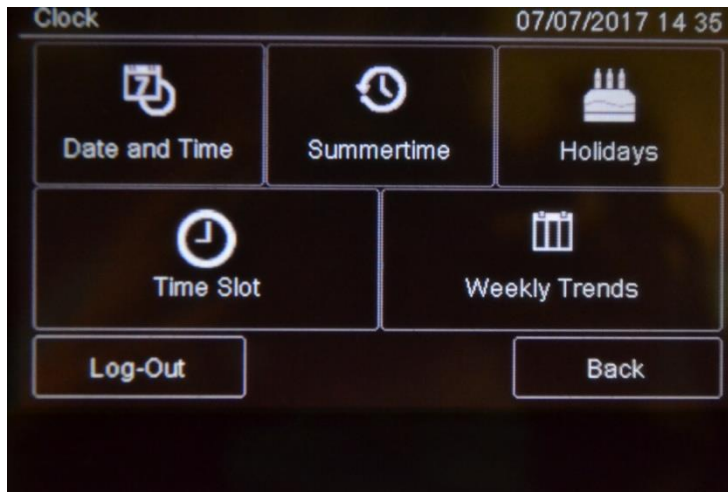

10.9.1 Setting the date and time

Programming menu -> Configure -> Date & Time -> Date and Time



Procedure

1. Set the current date and time.
2. Press **Save** to confirm.



Programming menu -> Configure -> Date & Time -> Summertime

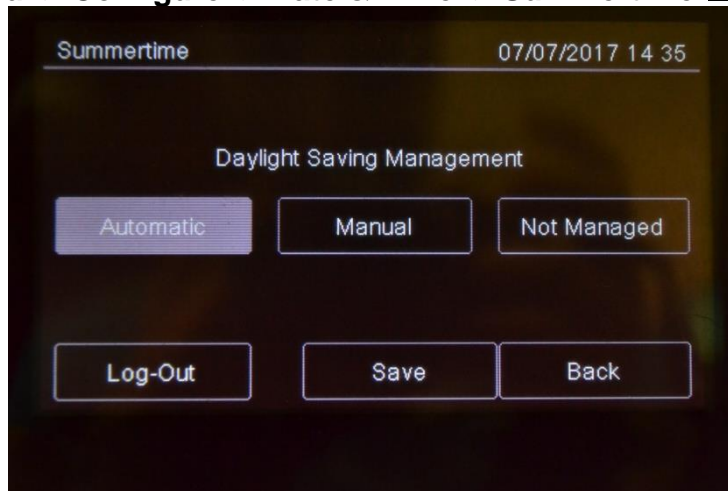

Settings

Settings are described below.

Parameter	Description
Automatic	The panel automatically switches to daylight savings time.
Manual	Manually set the month and day daylight savings time starts and ends.
Not managed	Function not enabled, no daylight savings time period is calculated.

10.9.3 Setting holidays



Programming menu -> Configure -> Date & Time -> Holidays

This function lets you program holidays.

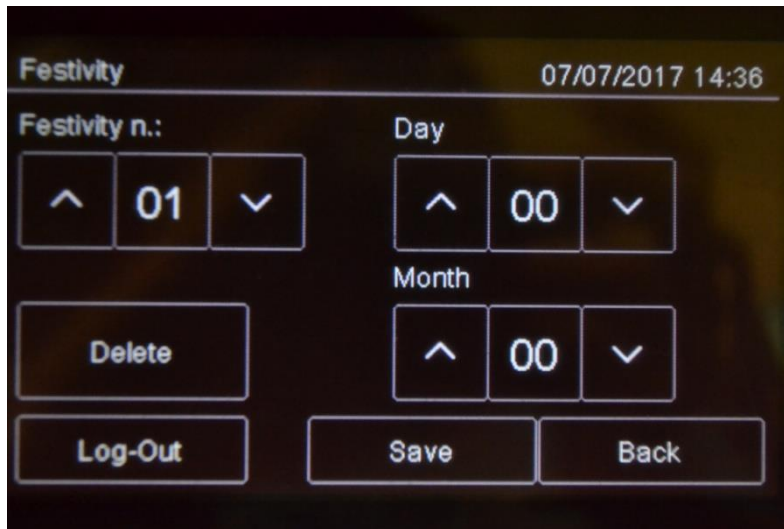

Settings

Settings are described below.

Parameter	Description
Holiday no.	Holiday ID (1-12)
Day	Holiday day
Month	Holiday month

10.9.4 Setting time intervals



Programming menu -> Configure -> Date & Time -> Time Slot ->

This function lets you set up to 255 daily time intervals.

Procedures

To create a new time interval:

1. Select the **Add** option: the list of time intervals is displayed.
2. Select a time interval not set.
3. Set the start date and time **[1]** and end date and time **[2]** for the time interval.
4. Press **Save** to confirm.

To edit an existent time interval:

1. Select the **Edit** option: the list of time intervals is displayed.
2. Select the time interval to be edited.
3. Change the start and end times.

4. Press **Save** to confirm.

To delete an existent time interval:

1. Select the **Delete** option: the list of time intervals is displayed.
2. Select the time interval to be deleted.
3. Press **Save** to confirm.

10.9.5 Setting weekly trends



Programming menu -> Settings -> Date & Time -> Weekly trends

This function lets you link previously created time intervals to days of the week.

Procedures

To create a new weekly trend proceed as following:

1. Select the **Add** option: the list of weekly trends is displayed.
2. Select a weekly trend not set.
3. Select the time interval to be linked for each day of the week. See *10.9.4 Setting time intervals* on how to create time intervals.
4. Press **Save** to confirm.

To edit an existent weekly trend:

1. Select the **Edit** option: the list of weekly trends is displayed.
2. Select the weekly trend to be edited.
3. Edit the time intervals linked to the days.
4. Press **Save** to confirm.

To delete an existent weekly trend:

1. Select the **Delete** option: the list of weekly trends is displayed.
2. Select the weekly trend to be deleted.
3. Press **Save** to confirm.

11. Use

11.1 Viewing events



The following functions are accessible to both the User and Programmer.



Event Log Menu

The **Event Log** menu lets you view events logged by category. See *9.1.1 Viewing events* for a description of the displayed information.

11.1.1 Exporting data



User menu -> Maintenance -> Export -> Events

This function will allow to export the event memory from the panel to a USB support.



The panel is compatible with USB supports with a capacity until 16Gb formatted in FAT32 with 4096 byte allocation table. It is necessary to format the device in such way with a PC.

Procedures

- Insert a compatible USB support by using a MiniUSB to USB adaptor.
- Go to the declared menu

Selecting “Events”, a .csv format file will be saved on the USB support, that can be opened with a software like Excel, called “EVNTLOG.CSV”.

If a file called “EVNTLOG.CSV” is already existing in the inserted USB support root, it will be overwritten, losing any previous past data exportation. Exporting time depends on the amount of events in memory. A panel with a full memory is around 60 seconds.



To avoid data corruption, do not disconnect the USB support, do not stop the exporting procedure and do not turn off the panel.

11.2 Enabling users and changing login codes

Only the Programmer operator can enable or disable user operator login. Each operator can change their personal login code.

11.2.1 Programmer

Programming menu -> Configure -> Password

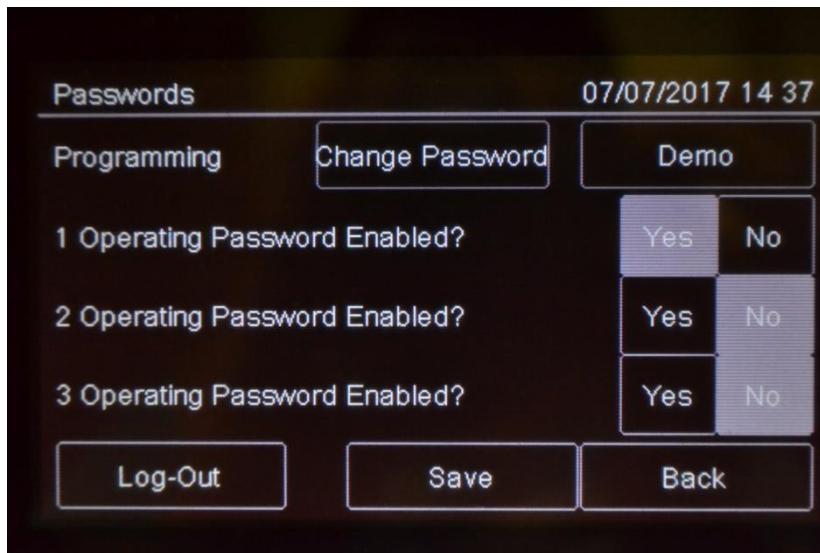

Procedures

To enable User login:

1. Set all Users who need to login to the unit to **Yes**.
2. Press **Save** to confirm.

To change the Programmer login code:

1. Select the **Change** option: the code change page is displayed.
2. Insert the new code.
3. Confirm the new code to save it.

11.3 Managing alarms

In case of alarm received from any device, the panel will activate immediately the internal siren output and will turn on the red LED on the front panel.

The device in alarm status will turn on its red LED.



To avoid a loop overload, in case of more than one alarm, a maximum of 10 red LEDs on the devices will be activated.



The following functions are reserved to the User

11.3.1 Mute alarms and the unit

User menu -> Silence 



Once this key is pressed, it is transformed into **Rearm**.

This function lets you temporarily mute system and panel alarms to check if a fire has actually broken out and reset them if necessary.

Procedures

In the event of false alarm:

Reset the panel (see 11.3.2 *Reset alarms and the unit*).

In the event of real alarm:

Press the **Siren Reset** key to turn sirens back on.

11.3.2 Reset alarms and the unit

User menu ->Reset 

This function resets triggered alarms and the unit.

If alarms or faults are not restored before the reset, after it will still be shown on the display from the central.



It's possible to perform a reset Hardware through the appropriate button on the master board.

11.3.3 Evacuation

User menu ->Evacuation 

This feature will put the panel into evacuation mode, activating all the outputs/sirens properly configured.

By activating the evacuation all the output modules programmed as "Activate evacuation" (see 10.4 *Modules*) will be activated, even if their zone is not active, and if the logic function where they are linked to is not yet valid.

11.4 Checking device status



The following functions are accessible to both the User and Programmer.

11.4.1 Check loop status



Maintenance -> Loop -> Status

Procedure

Select the required loop: loop type and status are displayed.

11.4.2 Resetting a loop



Maintenance -> Loop -> Reset

Select the required loop: this is automatically reset.

11.4.3 Run device diagnostics



Maintenance -> Diagnostics

This function lets you check connected device cleanliness.

Sensor status

Sensor status is indicated by the following colors:

Color	Device conditions
	Clean detector
	Medium clean detector
	Almost dirty detector
	Dirty detector

Procedure

1. Select the required loop: all connected devices are displayed.
2. Press a single sensor to view details.

11.4.4 Diagnostics export.

User Menu -> Maintenance-> Export -> Diagnostics



This function will allow to export the device diagnostics connected to the panel, to a USB support.



The panel is compatible with USB supports with a capacity until 16Gb formatted in FAT32 with 4096 byte allocation table. It is necessary to format the device in such way with a PC.

Procedure

- Insert a compatible USB support by using a MiniUSB to USB adaptor.
- Go to the declared menu
- Select the desired loop.
- On the USB support a .csv format file will be created, that can be opened with a software like Excel, called "1DIAGLP.CSV", where the number in front of the file is the selected loop of the panel.

If a file called "xDIAGLP.CSV" is already existing in the inserted USB support root, it will be overwritten, losing any previous past data exportation. Exporting time depends on the amount of devices connected to the desired loop. A loop with 240 devices connected, the exporting time is around 240 seconds.



To avoid data corruption, do not disconnect the USB support, do not stop the exporting procedure and do not turn off the panel.

11.5 Testing devices



The following functions are accessible to both the User and Programmer.

11.5.1 Running a Walk Test

Maintenance -> Test -> Sensors/Modules -> Walk Test



Walk test is used to check that the devices are able to generate an manually.



When devices are in this mode, the system does not generate any alarm and does not run the relevant procedures.

Different types of tests can be run:

- **Single:** used to test only one device.
- **Zone:** used to test devices in a specific zone.
- **Loop:** used to test devices in a specific loop.

Test results

The results are indicated by a color for all tests.

Color	Device conditions
	Test successfully completed.
	Device still not gone to alarm status.

Procedures

To run a single test:

1. Press the **Single** option.
2. Select the device loop and address.

To run a zone test:

1. Press the **Zone** option.
2. Select the required zone.

To run a loop test:

1. Press the **Loop** option.
2. Select the desired loop.

11.5.2 Testing the connection with modules and sensors



Maintenance -> Test -> Sensors/Modules -> Sensors/Modules

Device connection

Connection status is indicated by a color for all devices.

Color	Device conditions
	Device correctly connected.
	Device connection error

Procedures

To test the device connection:

1. Select the desired loop.
2. Select the device address: the connection status with each loop device is displayed by a color. The below example illustrates a correct communication with loop 1 sensor 229.

11.5.3 Identifying conflicts



Maintenance -> Test -> Conflicts

This function lets you check whether two devices have the same address on the same loop, in the system.

1. Select the loop where conflicts have to be searched: any conflicts are automatically displayed.
2. If several devices are displayed with the same address, change one.

11.5.4 Identifying mismatches



Maintenance -> Test -> Mismatch

This function lets you check whether the device on the loop correspond really to the device typology configured in the panel (for example, whether a detector was programmed as a module or vice versa).

1. Select the loop where mismatches are searched for: any mismatch is automatically displayed.
2. Correct any found mismatch.

11.5.5 Testing led operations



Maintenance -> Test -> Led

This function lets you check whether all the LEDS on the panel and the RGB display values are correctly working.

11.6 Disable system elements



The following functions are accessible to both the User and Programmer.



Maintenance -> Disablements



Disabled devices do not send any alarm or fault signal. This compromises system safety. Only disable a device with strictly necessary and re-include it as soon as possible.

This function lets you bypass and re-include one or more unit devices. This feature will ignore any information received by the excluded device.

It is possible to disable:

- devices
- loop
- zones
- outputs
- Protected or not protected zone

Element conditions

Symbol	Element condition
	Disabled element (detector in the example)
	Enabled element (detector in the example)

11.6.1 Disabling/Enabling a device



Maintenance -> Disablements -> Devices

Procedures

To disable a detector:

1. Select the loop that contains the device to be bypassed.
2. Select the device to be bypassed.
3. Press **Save** to confirm. Sensor 001 is bypassed in the example.

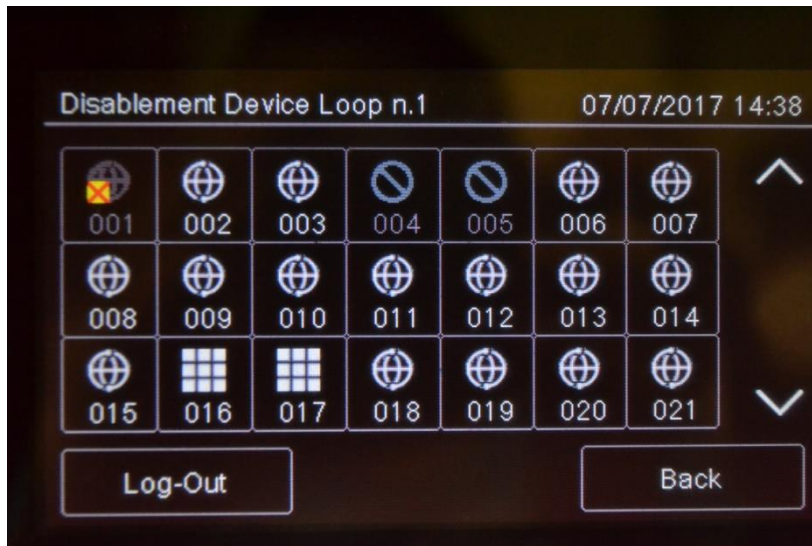

To enable a previously bypassed detector:

1. Select the loop that contains the device to be included.
2. Select the bypassed device to be included.
3. Press **Save** to confirm.

11.6.2 Disabling/Enabling a loop

Maintenance -> Disablements -> Loop 



Warning: bypassing a loop automatically bypasses all devices connected to it.

Procedures

To disable a loop:

1. Select the loop to be bypassed.
2. Press **Save** to confirm. Loop 1 is bypassed in the example.

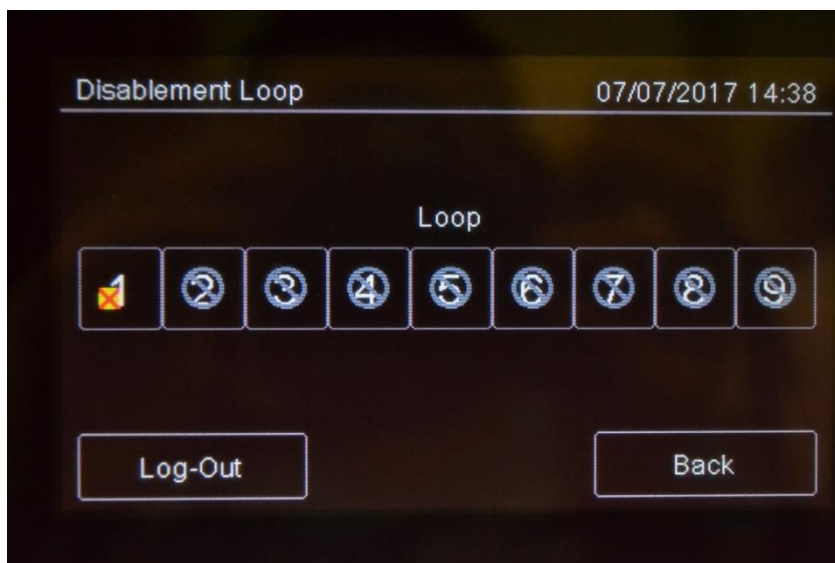

To enable a previously bypassed loop:

1. Select the bypassed loop to be included.
2. Press **Save** to confirm.

11.6.3 Disabling/Enabling a zone

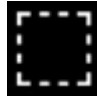

Maintenance -> Disablements -> Zone



Warning: bypassing a zone automatically bypasses all connected loops and relevant devices.

Procedures

To disable a zone:

1. Select the zone to be bypassed:
2. Press **Save** to confirm.

To enable a previously bypassed zone:

3. Select the bypassed zone to be included.
4. Press **Save** to confirm.

11.6.4 Disabling/Enabling an output



Maintenance -> Disablements -> Outputs

Procedures

To disable an output:

1. Select **Yes** for each output to be bypassed.
2. Press **Save** to confirm.

To enable an output:

1. Select **No** for each output to be included.
2. Press **Save** to confirm.

It's possible to disable:

All Outputs, Panel monitored output, Sonders, Zones, Output Zones

11.6.5 Disabling/Enabling Protected



Maintenance -> Disablements -> Protected

Here it's possible to disable/enable Protected zone mode.

When a zone is shown in green, protected is enabled.

11.7 Modify a user password (second level only)



The following functions are reserved to the User.



Maintenance -> Change password

This feature will permit to modify the password of the logged user.

To modify the User password:

1. Select the **Change** option: the code change page is displayed.

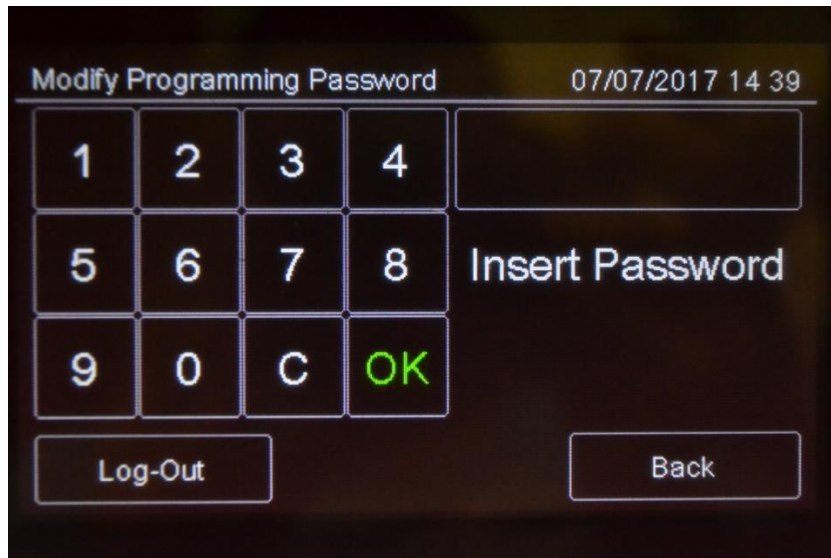

2. Insert the new code.
3. Confirm the new code to save it.

This new code must be used at the next login



Each user can modify their password. To activate other users (max 3) see paragraph 11.2.

11.7.1 Reminder



Maintenance -> Maint. Expiry

Here it's possible to program a message when maintenance time is expired.

A pop up event will appear at midnight of date set.